

Pemborkeshire 53

Art. Nr. 4414740

1/8

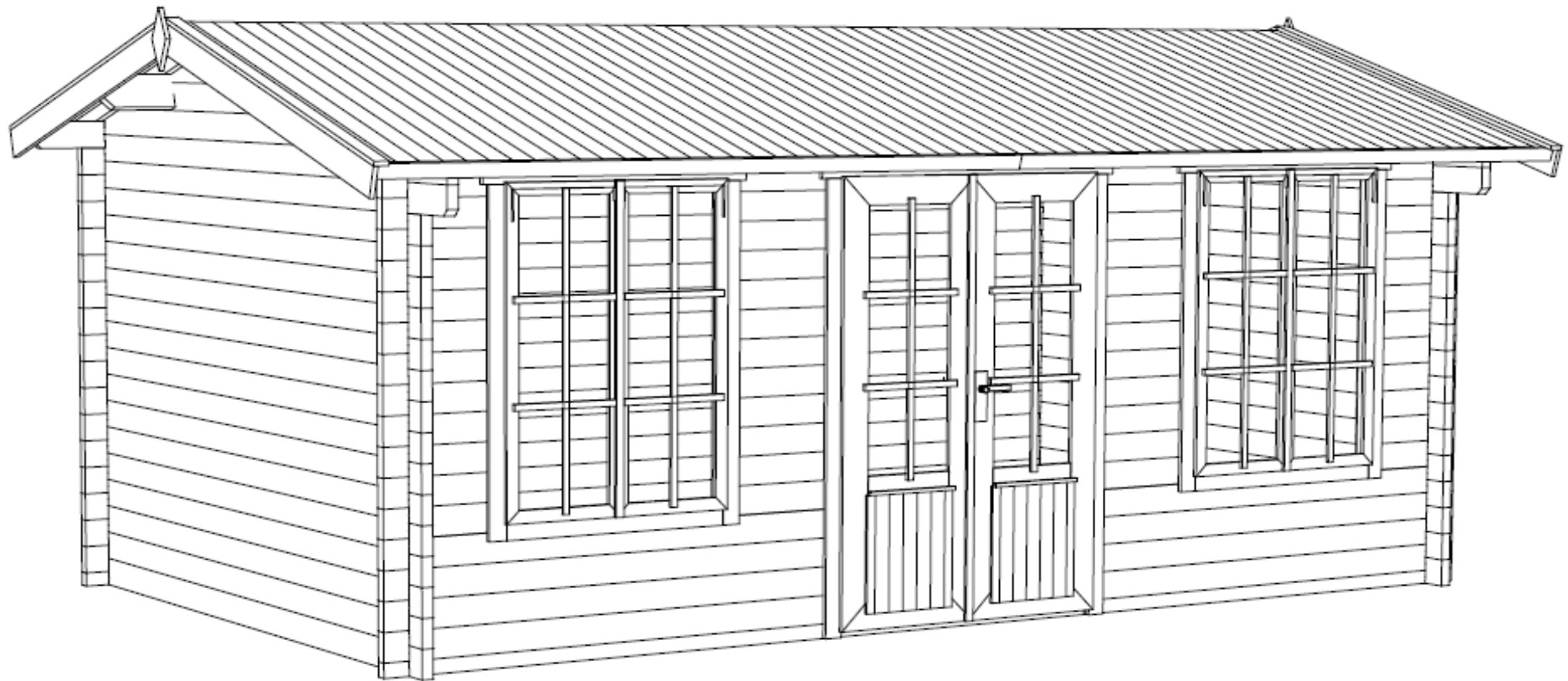

4.10.2013





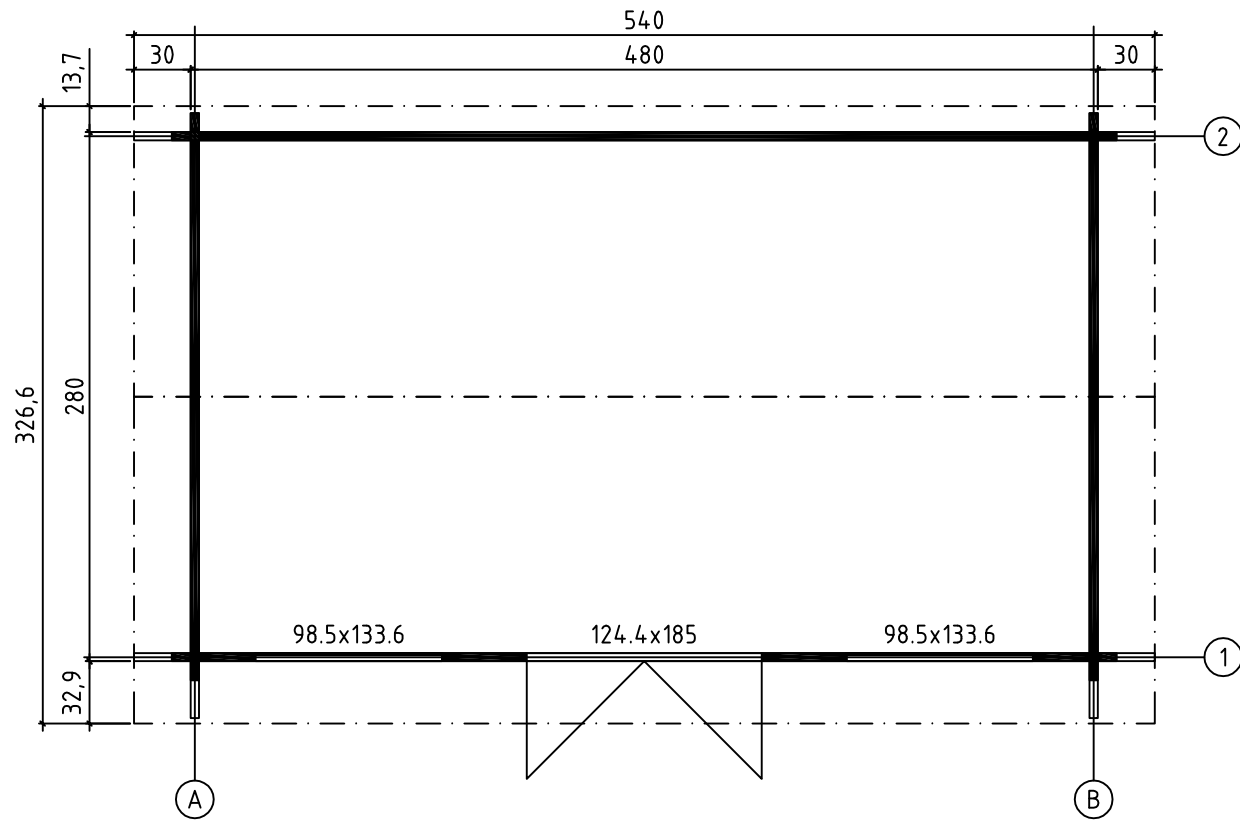

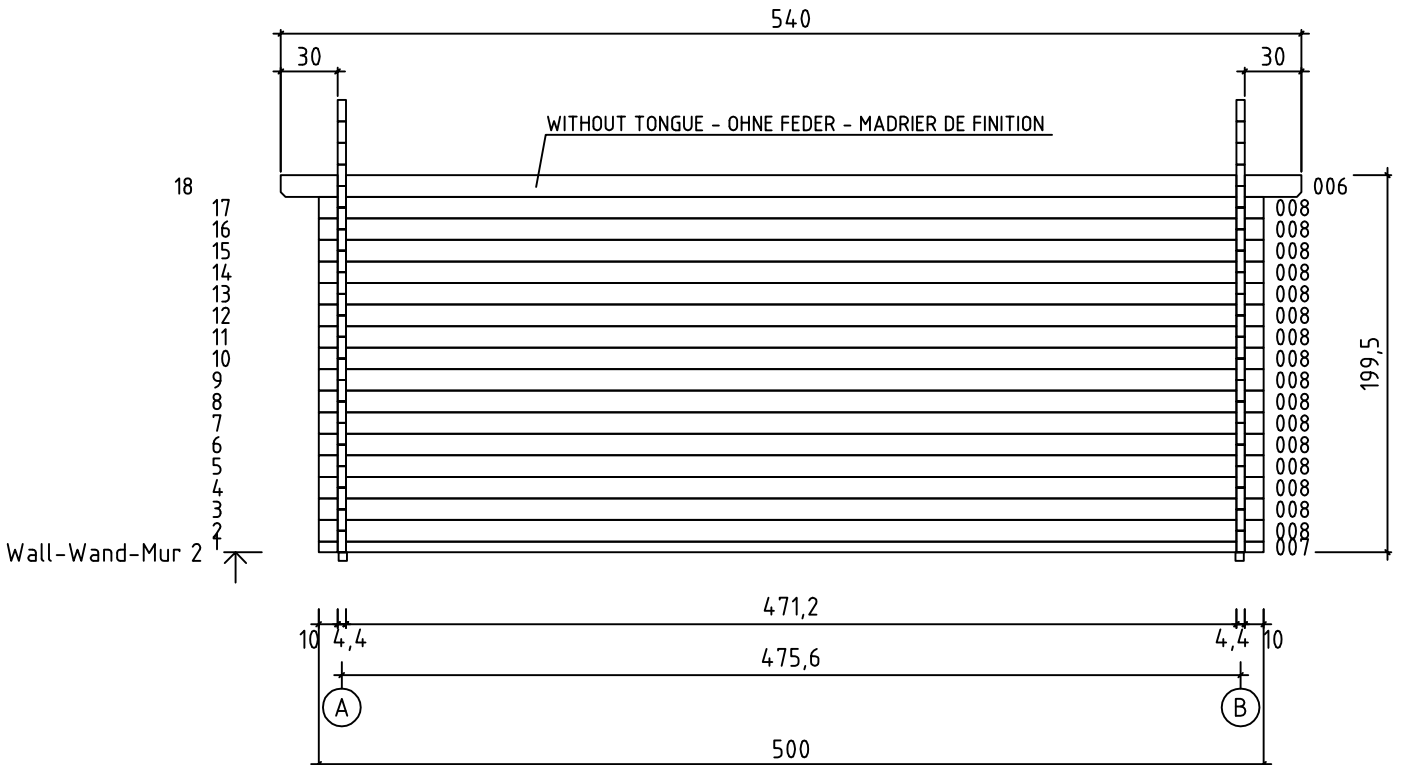
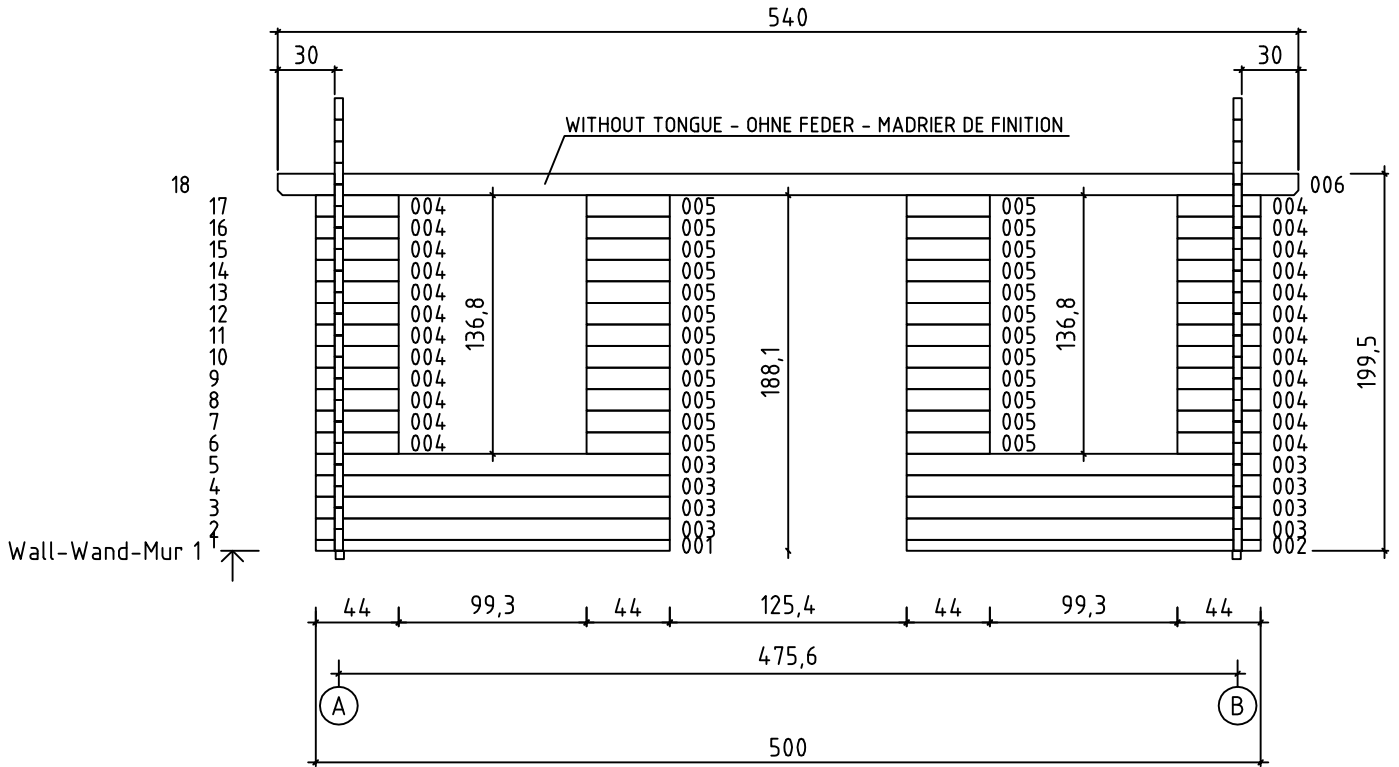

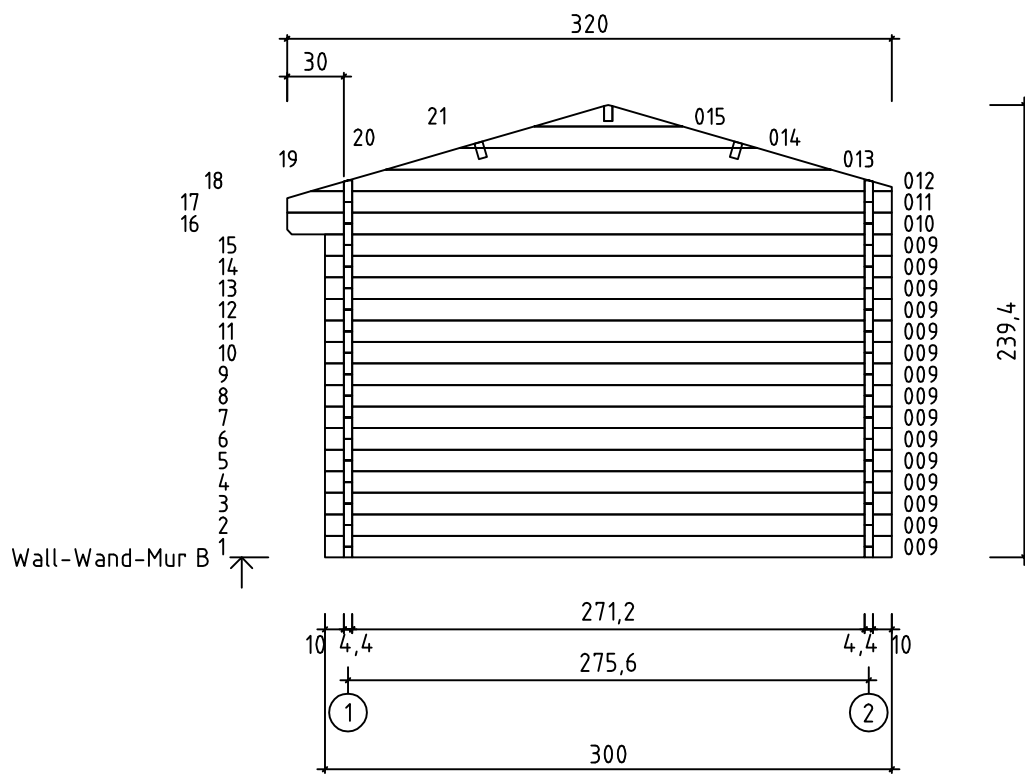
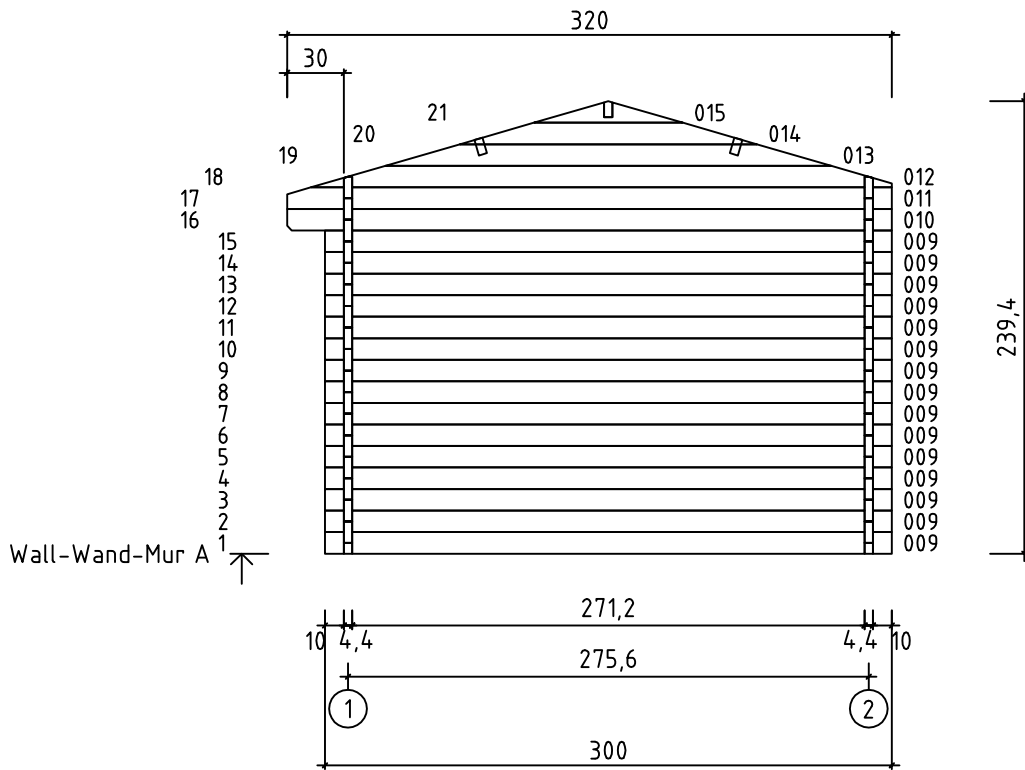

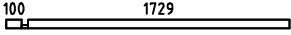
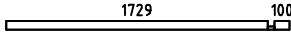
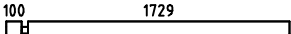
Art.Nr. 4414740

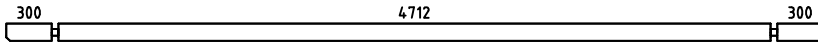
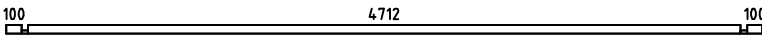
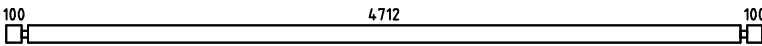
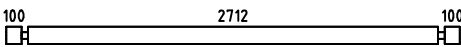
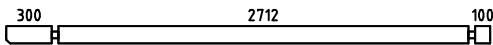
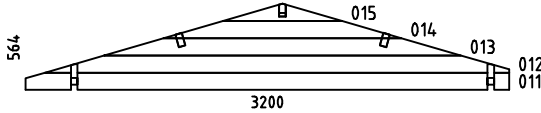

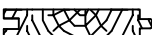







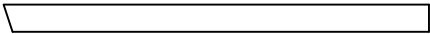
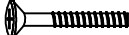

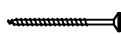
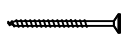
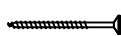

GROUNDPLAN - GRUNDPLAN - PLAN DE MASSE

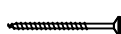

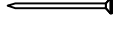

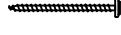

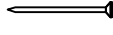
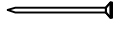
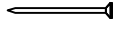
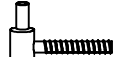
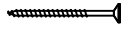
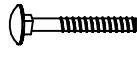
Pos	04.10.2013	Piecelist - Stücklist - Liste des composants Art.Nr. 4414740	6/8	Q.	P. (mm)	L. (mm)
001				1	44x57	1873
002				1	44x57	1873
003				8	44x114	1873
004				24	44x114	440
005				24	44x114	440
006				2	44x120	5400
007				1	44x57	5000
008				16	44x114	5000
009				30	44x114	3000
010				2	44x114	3200
WA-1 WB-1				1 1		
IAR2	FOUNDATION - FUNDAMENT - FONDATION			8	45x45	4700
IAR1	FOUNDATION - FUNDAMENT - FONDATION			2	45x45	2790
PR1	ROOF BEAM - DACHBALKEN - PANNE DE TOIT			1	44x140	5400
A-PR1	ROOF BEAM - DACHBALKEN - PANNE DE TOIT			2	44x140	5400
	FLOOR BOARDS - FUSSBODENBRETTER - LAME DE PLANCHER			53	90x18	2708
	ROOF BOARDS - DACHBRETTER - VOLIGES			60	90x18	1800
	ROOF BOARDS - DACHBRETTER - VOLIGES			60	90x18	1600
	FLOOR FILLET-FUSSBODENLEISTE - CORNIERE DE FINITION DU PLANCHER				18x18	14.83
	ROOFING FELT FILLET - DACHPAPPENLEISTE - BAGUETTE DE FIXATION DU FEUTRE BITUMEUX			2	18x58	1650
	ROOFING FELT FILLET - DACHPAPPENLEISTE - BAGUETTE DE FIXATION DU FEUTRE BITUMEUX			2	18x58	1850
	EAVES BOARD - TRAUFBRETT - BANDEAU DE TOIT			4	18x58	2700
	ROOF EDGE REINFORCEMENT - DACHRANDVERSTÄRKUNG - CORNIERE DE RENFORT DE BORD DE TOIT			4	28x34	2700
	STORM PROTECTION - STURMLEISTE - - LATTE ANTI-TEMPETE			4	22x45	1900

Pos	04.10.2013	Piecelist - Stücklist - Liste des composants Art.Nr. 4414740	7/8	Q.	P. (mm)	L. (mm)
		GABLE MOULDING - GIEBELLEISTE - - PLANCHE DE RIVE		2	18x120	1650
		GABLE MOULDING - GIEBELLEISTE - - PLANCHE DE RIVE		2	18x120	1850
		BOLT FOR WINDOW HANDLE FITTINGS - BOLZEN FÜR FENSTERGRIFF BESCHLAG - BOULON POUR POIGNÉE D'OUVERTURE DE FENETRE		4		
		SCREW FOR ROOF BEAMS - SCHRAUBEN FÜR DACHBALKEN - VIS POUR PANNE DE TOIT		10	5x120	
		SCREW FOR 1. WALL BEAM - SCHRAUBE FÜR 1. BOHLENREIHE - VIS DE FIXATION DES FONDATIONS		8	5x90	
		SCREW FOR DOOR JAMB - SCHRAUBE FÜR TÜRRAHMEN - VIS DE FIXATION POUR MONTANT DE PORTE		4	5x90	
		SCREW FOR GEORGIAN BARS - SCHRAUBE FÜR SPROSSEN - VIS DE BARRES GEORGIENNE		36	2.5x20	
		SCREW FOR GABLE SEGMENT - SCHRAUBEN FÜR DECKBLATT - VIS POUR FIXATION LOSANGE DE FINITION		4	3.5x35	
		SCREW FOR GABLE MOULDING - SCHRAUBEN FÜR GIEBELLEISTE - VIS DE FIXATION POUR PLANCHE DE RIVE		24	3.5x50	
		SCREW FOR DOOR FILLET - SCHRAUBE ZUR BEFESTIGUNG TÜRLEISTE - VIS D'ASSEMBLAGE DU CADRE DE PORTE		5	3x30	
		SCREW FOR EAVES BOARDS - SCHRAUBEN FÜR TRAUFBRETTEN - VIS DE FIXATION POUR BANDEAU DE TOIT		24	4x40	
		SCREW FOR FUNDAMENT - SCHRAUBEN ZUR BEFESTIGUNG FUNDAMENT - VIS POUR FONDATION		24	5x90	
		WINDOW HANDLE FITTINGS - FENSTERGRIFF - POIGNÉE D'OUVERTURE DE FENETRE		2		
		ZN NAIL FOR FLOOR FILLET - ZN NÄGEL FÜR FUSSBODENLEISTE - POINTE POUR CORNIERE DE FINITION DU PLANCHER		30	1.4x40	
		SET OF DOOR LOCK COVERS - SCHLOSSBLENDEN - SET DE GARNITURES DE SERRURE DE PORTE		1		
		HAMMER BLOCK - SCHLAGHOLZ - CALLE DE FRAPPE		1		
		SCREW FOR DOORSTEP - SCHRAUBEN FÜR SWELLE - VIS DE FIXATION DU SEUIL DE PORTE		3	4.5x65	
		NUT FOR STORM PROTECTION - SCHRAUBENMUTTER FÜR STURMLEISTE - ÉCROU POUR LAME ANTI-TEMPETE		8		
		ZN NAIL FOR ROOF - ZN NÄGEL FÜR DACHBRETTEN - POINTES DE FIXATIONS DES VOLIGES DE TOIT		374	2x50	
		ZN NAIL FOR FLOOR - ZN NÄGEL FÜR FUSSBODENBRETTEN - CLOUS POUR PLANCHER		324	2x50	
		ZN NAIL FOR ROOFING FELT FILLET - ZN NÄGEL FÜR DACHPAPPENLEISTE - POINTE POUR BAGUETTE FIXATION FEUTRE BITUMEUX		20	2x40	
		MALE BOLT HINGE FOR DOOR - TÜRRIEGEL - PARTIE MALE DE CHARNIERE DE PORTE		6		
		SCREW FOR ROOF EDGE REINFORCEMENT - SCHRAUBEN FÜR DACHRANDVERSTÄRKUNG - VIS POUR RENFORT DE BORD DE TOIT		24	4x40	
		BOLT FOR STORM PROTECTION - BOLZEN FÜR STURMLEISTE - VIS POUR LAME ANTI-TEMPETE		8	8x80	
		GABLE SEGMENT - DECKBLATT - LOSANGE DE FINITION		2		

