

Inverness 44
Art. Nr. 4416005
1/11

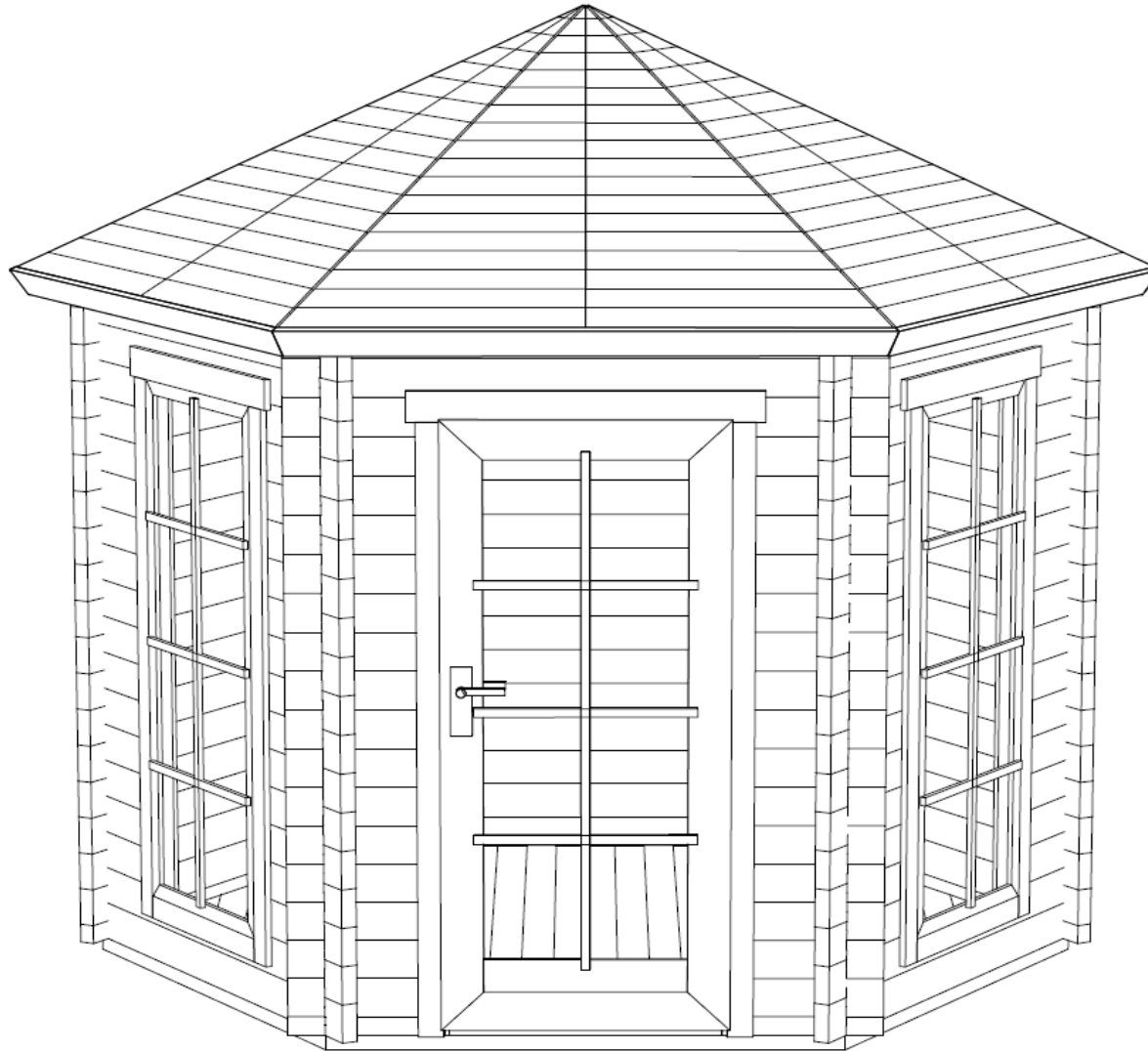

Art.Nr. 4416005

GROUNDPLAN - GRUNDPLAN - PLAN DE MASSE

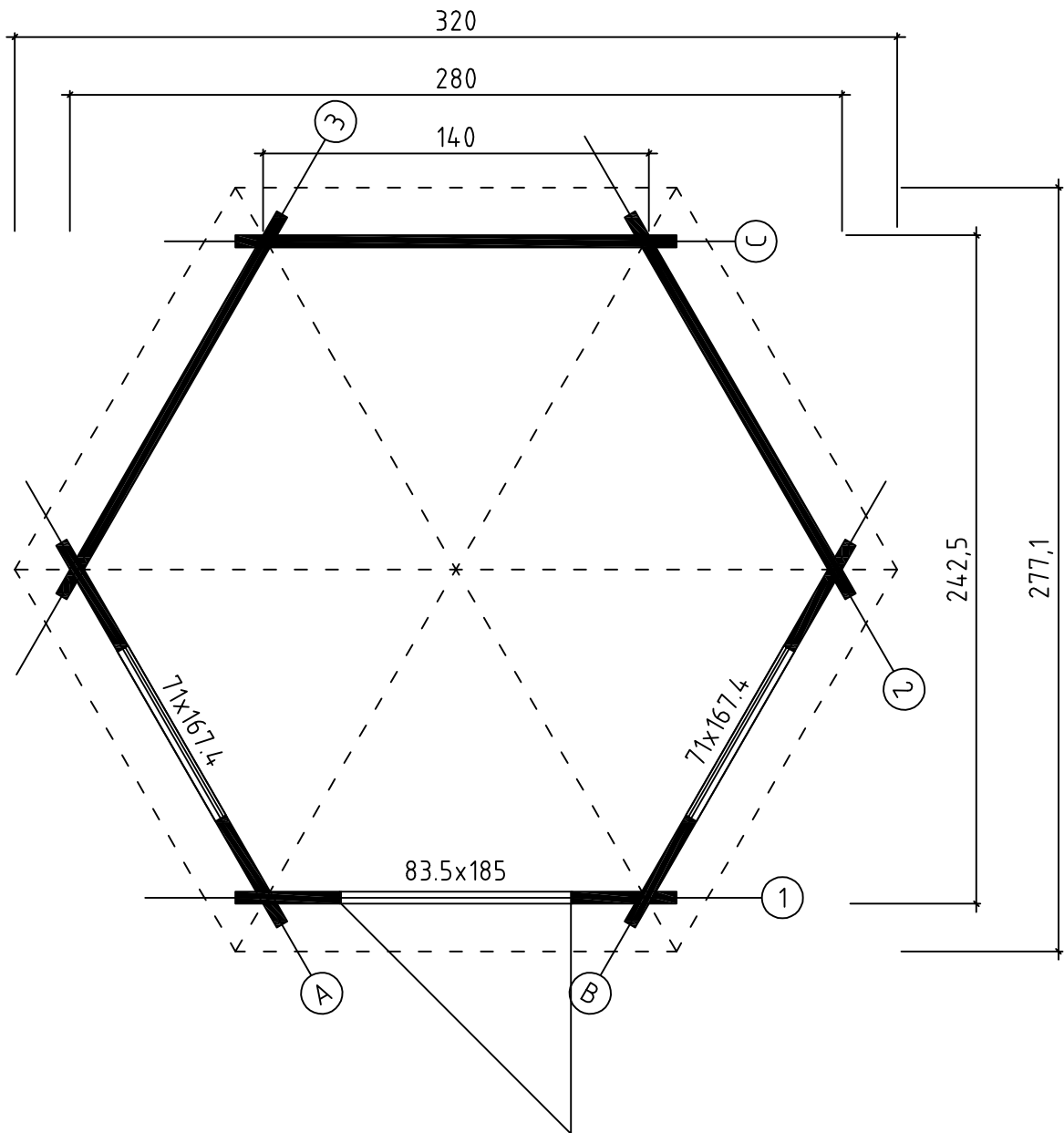

FOUNDATION - FUNDAMENT - FONDAZIONE

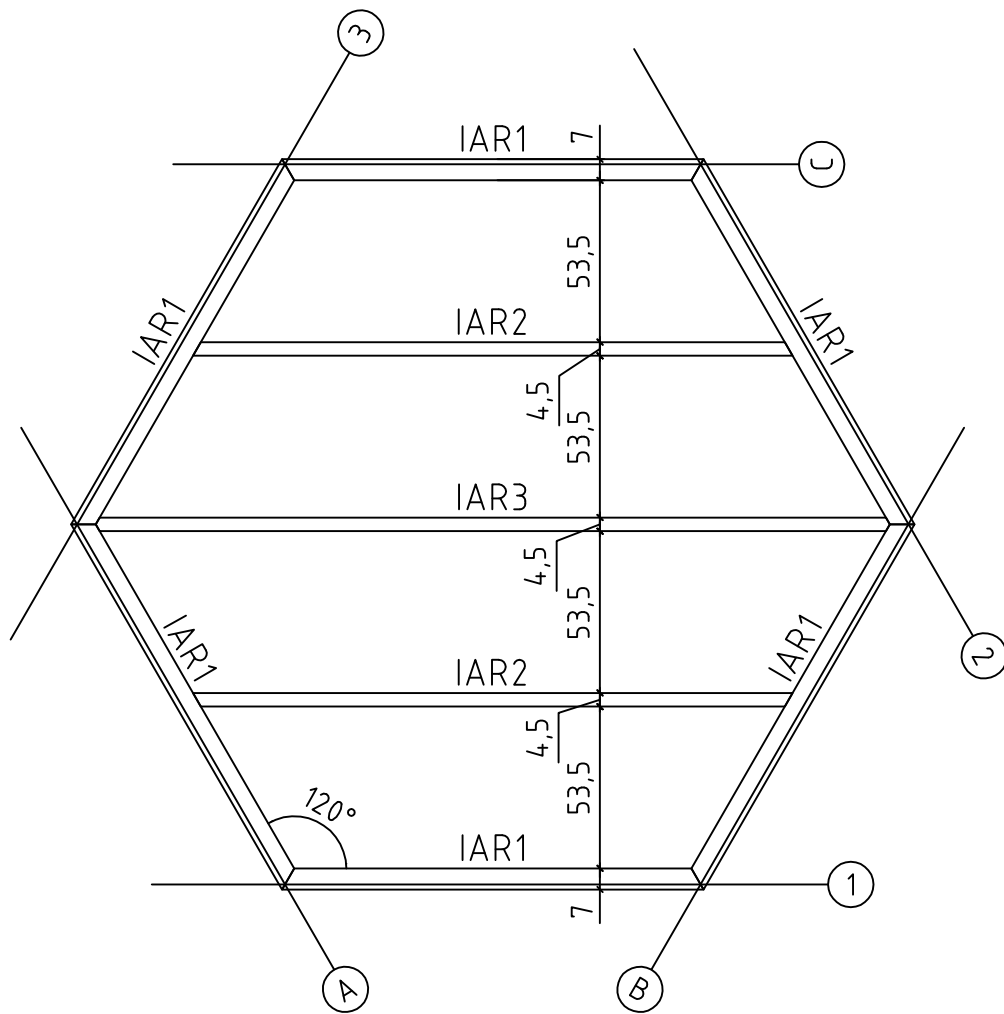

Art.Nr. 4416005

FLOOR BOARDS - FUSSBODENBRETTER - PLAN POSE PLANCHER

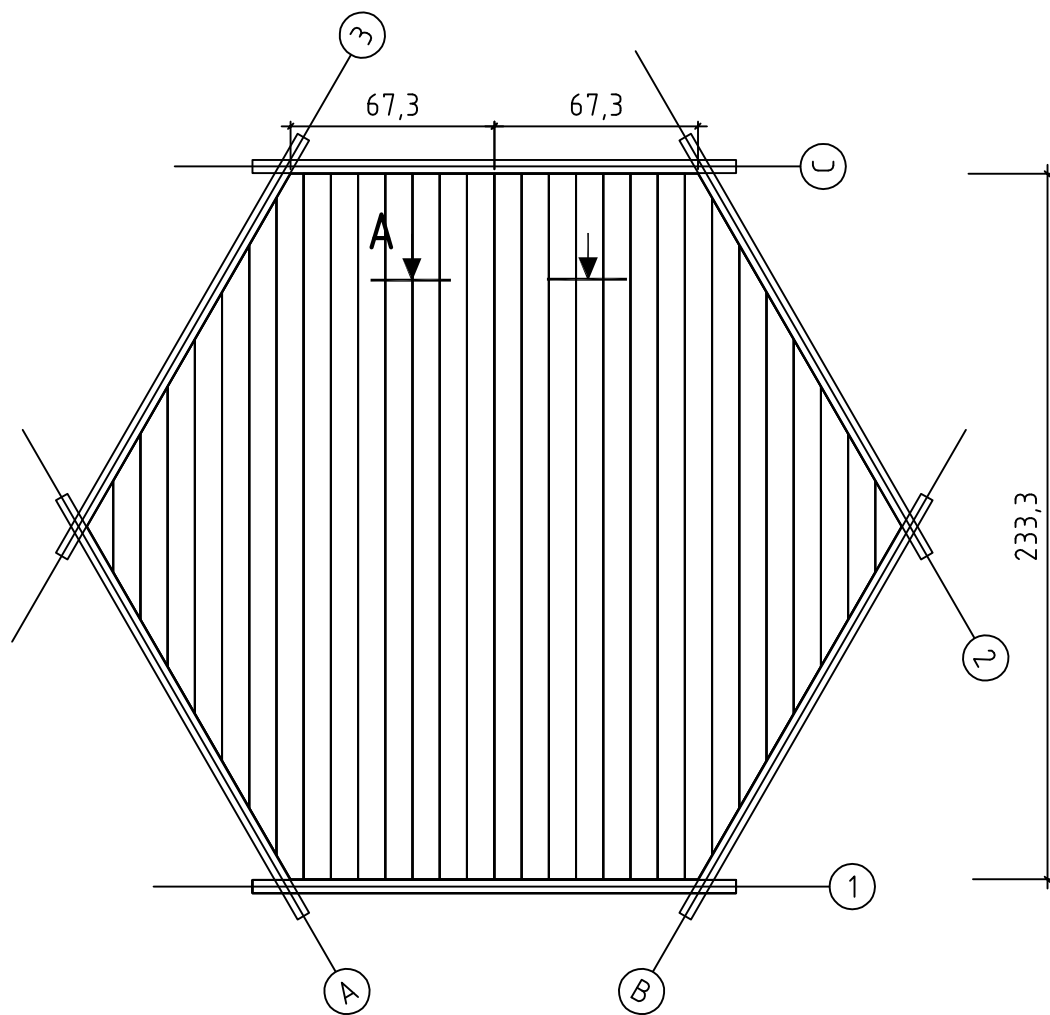

A - A

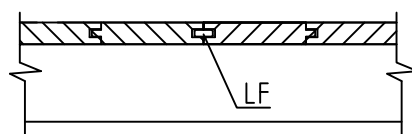

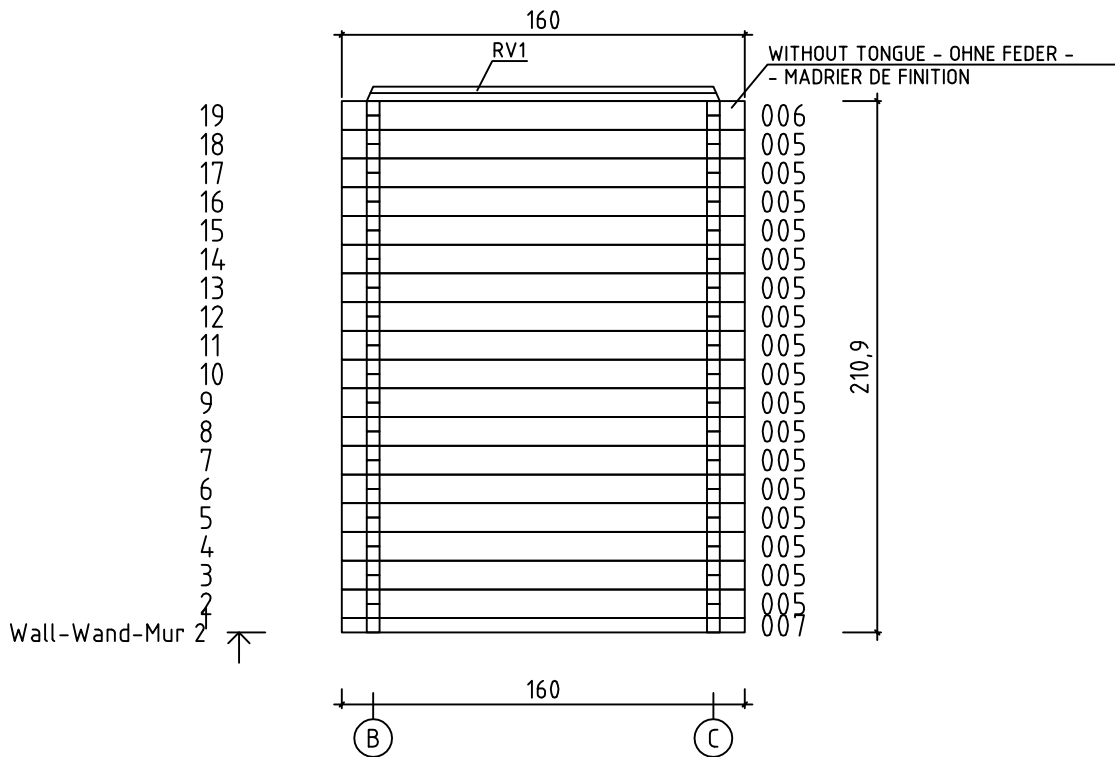
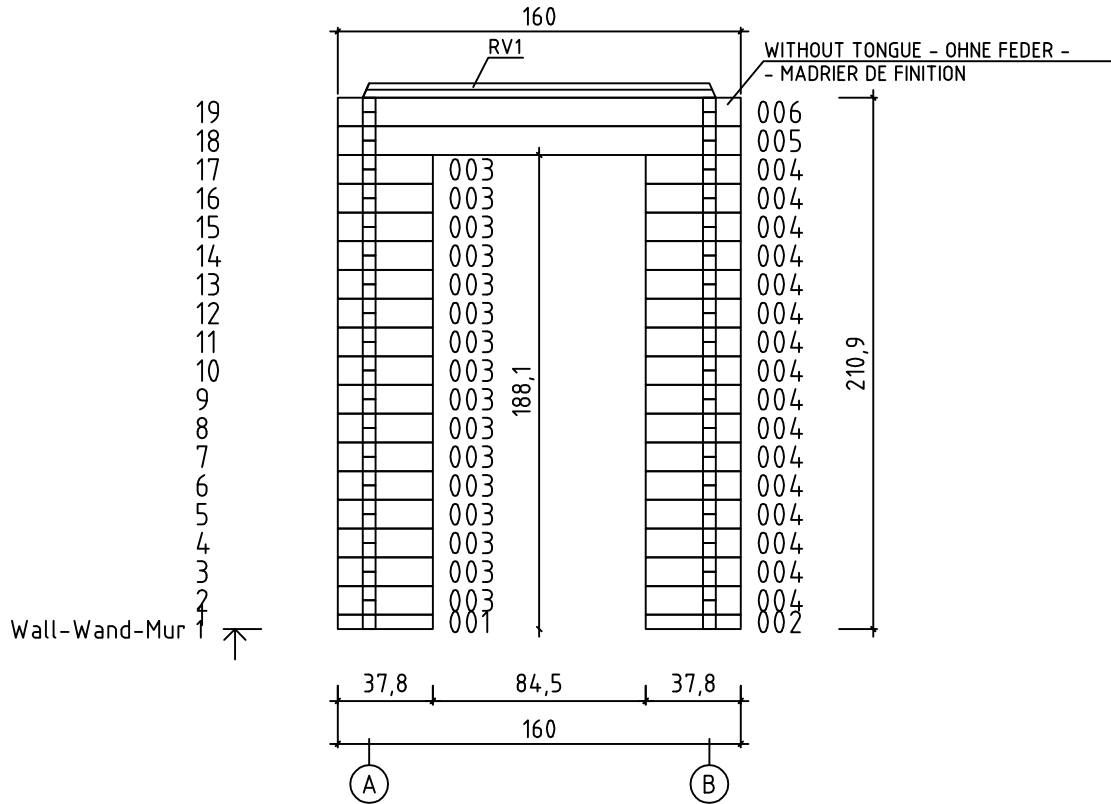

Art.Nr. 4416005

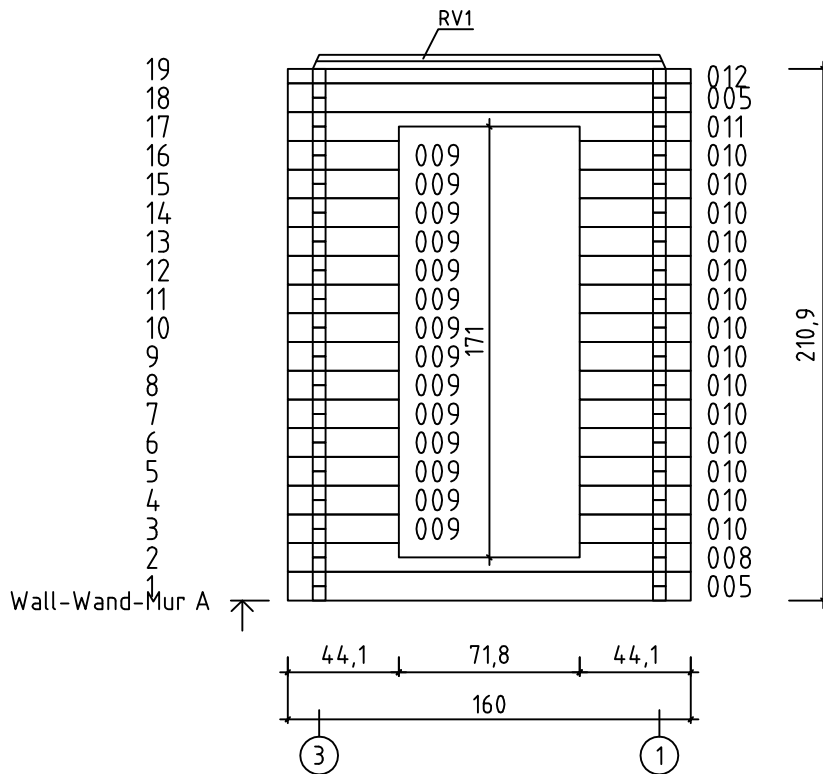
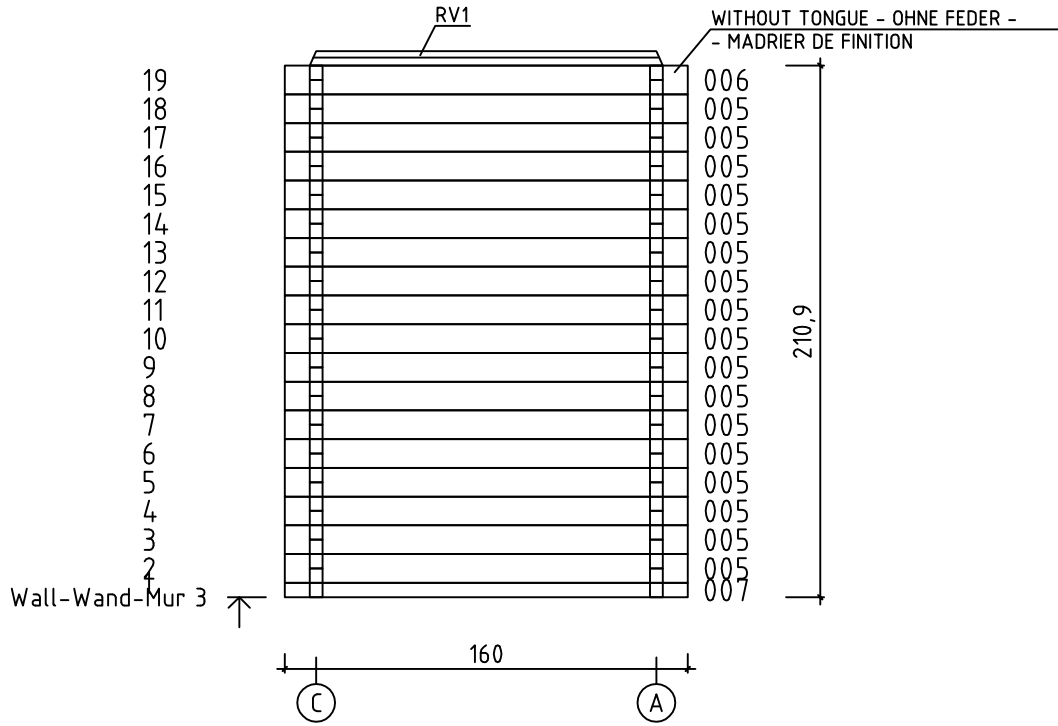

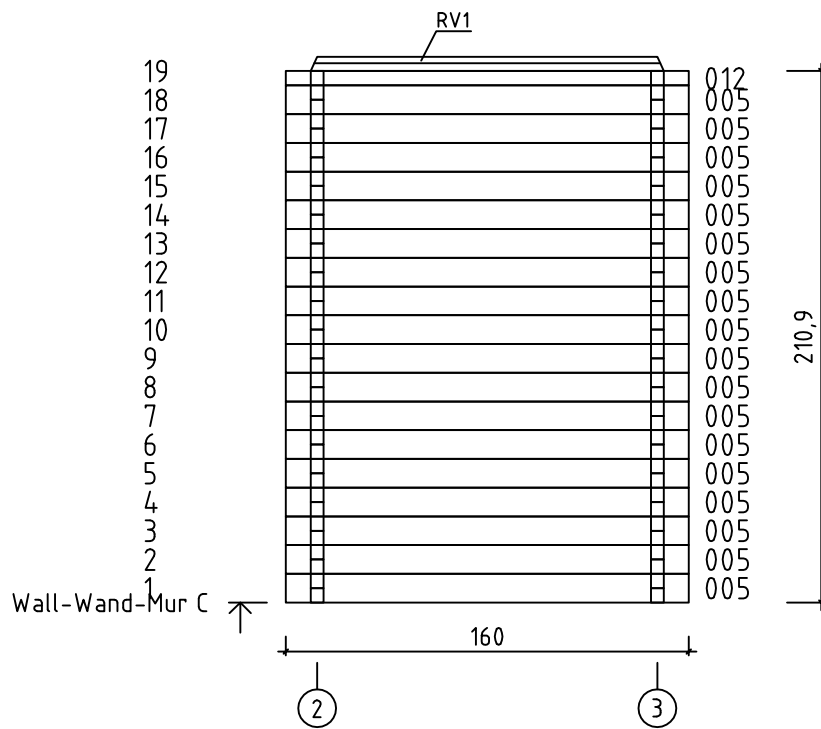
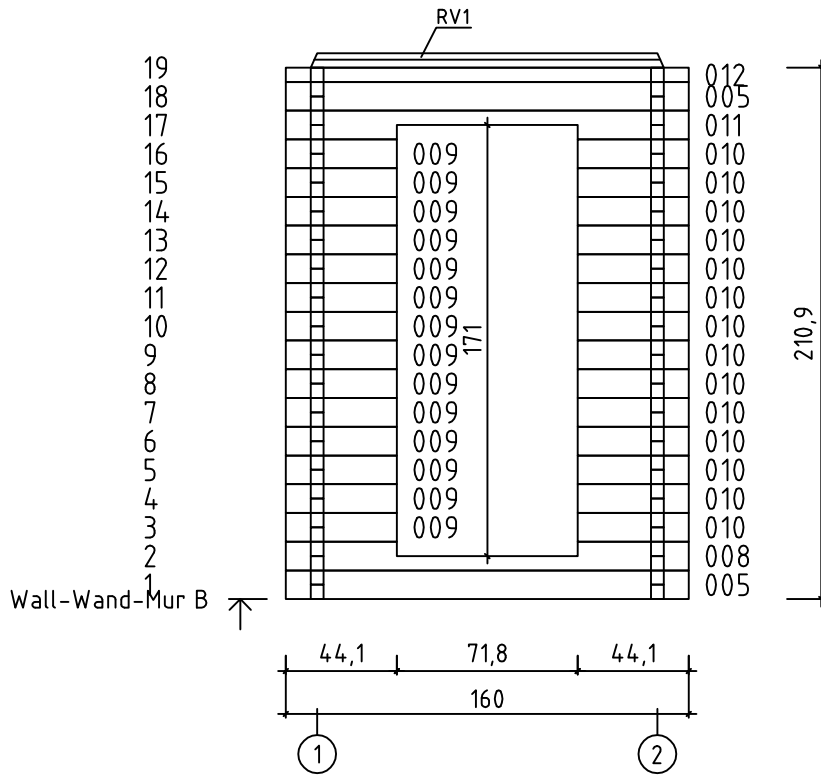

Art.Nr. 4416005

ROOF ELEMENTS - DACHELEMENTEN - PANNEAU DE TOIT PRÉMONTÉ

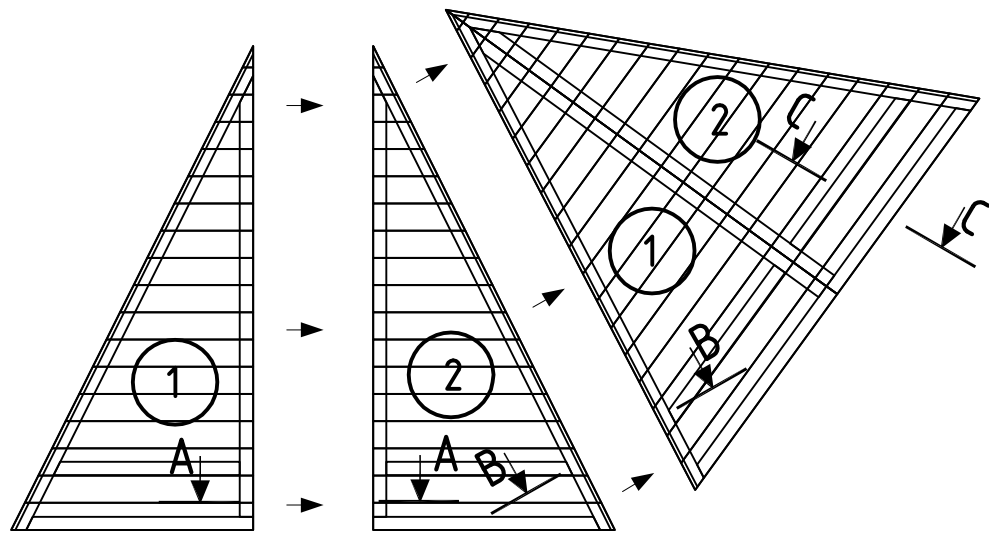

A - A

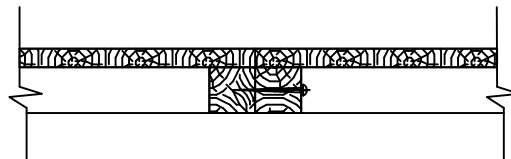

B - B

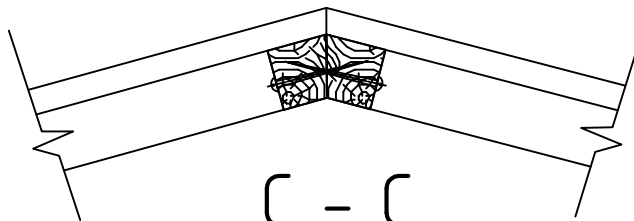

C - C

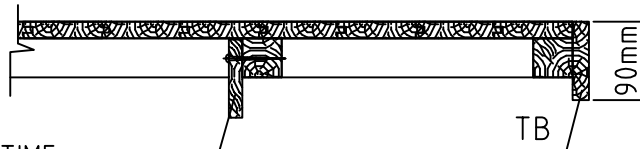













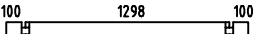
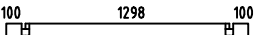
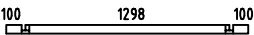
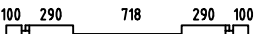

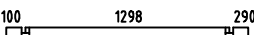
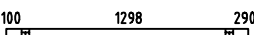









FIX THE FILLET (ML) FOR THE TIME OF ASSEMBLY - BITTE DAS BRETT (ML) FÜR DIE MONTAGE FESTSCHRAUBEN DAMIT DAS DACHELEMENT NICHT RUTSCH

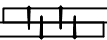

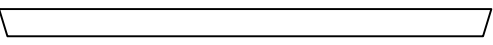
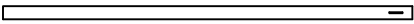

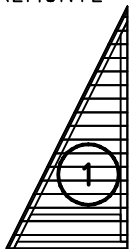
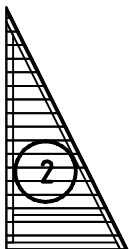
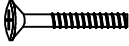
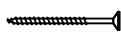

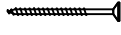
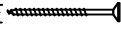
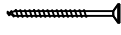
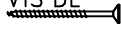
BAGUETTES DE MAINTIEN, (ML) NÉCESSAIRES À LA MISE EN PLACE DES PANNEAUX DE TOIT DOIVENT ÊTRE ENLEVÉS APRÈS MISE EN PLACE DU TOIT

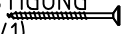
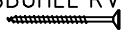
25.04.2014

8/11

Pos	25.04.2014	Piecelist - Stücklist - Liste des composants Art.Nr. 4416005	9/11	Q.	P. (mm)	L. (mm)
001				1	44x57	378
002				1	44x57	378
003				16	44x114	378
004				16	44x114	378
005				57	44x114	1600
006	 WITHOUT TONGUE - OHNE FEDER - MADRIER DE FINITION			3	44x114	1600
007				2	44x57	1600
008				2	44x114	1600
009				28	44x114	441
010				28	44x114	441
011				2	44x114	1600
012				3	44x57	1600
IAR1		FOUNDATION - FUNDAMENT - FONDATION		6	70x45	1394
IAR3		FOUNDATION - FUNDAMENT - FONDATION		1	45x45	2627
IAR2		FOUNDATION - FUNDAMENT - FONDATION		2	45x45	1983
RV1		WALL FINISHING BOARD - ABSCHLUSSBOHLE - MADRIER SUPÉRIEUR DE FINITION		6	44x57	1400
	FLOOR BOARDS - - FUSSBODENBRETTER - - LAME DE PLANCHER			14	90x18	2333
	FLOOR BOARDS - - FUSSBODENBRETTER - - LAME DE PLANCHER			2	90x18	2333
	FLOOR BOARDS - - FUSSBODENBRETTER - - LAME DE PLANCHER			2	90x18	2172
	FLOOR BOARDS - - FUSSBODENBRETTER - - LAME DE PLANCHER			2	90x18	1860
	FLOOR BOARDS - FUSSBODENBRETTER - - LAME DE PLANCHER			2	90x18	1548
	FLOOR BOARDS - FUSSBODENBRETTER - - LAME DE PLANCHER			2	90x18	1236
	FLOOR BOARDS - FUSSBODENBRETTER - - LAME DE PLANCHER			2	90x18	925
	FLOOR BOARDS - FUSSBODENBRETTER - LAME DE PLANCHER			2	90x18	613
	FLOOR BOARDS - FUSSBODENBRETTER - LAME DE PLANCHER			2	90x18	301

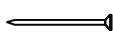
Pos	25.04.2014	Piecelist - Stücklist - Liste des composants Art.Nr. 4416005	10/11	Q.	P. (mm)	L. (mm)
		FLOOR FILLET-FUSSBODENLEISTE - CORNIERE DE FINITION DU PLANCHER			18x18	8.09
		ASSEMBLY BATTEN - MONTAGELATTE - BAGUETTES DE MAINTIEN, NÉCESSAIRES À LA MISE EN PLACE DES PANNEAUX DE TOIT		2	28x34	1800
LF		FITTING SLAT - LOSE FEDER - PROFIL DE JONCTION		1	6x15	2333
TB		EAVES BOARD - TRAUFBRETT - - BANDEAU DE TOIT		6	18x90	1628
		STORM PROTECTION - STURMLEISTE - - LATTE ANTI-TEMPETE		6	22x45	2000
ML		ASSEMBLY BATTEN - MONTAGELATTE - BAGUETTES DE MAINTIEN, NÉCESSAIRES À LA MISE EN PLACE DES PANNEAUX DE TOIT		12	18x90	
1		ROOF ELEMENT (LEFT) - DACHELEMENT (LINKE) - PANNEAU DE TOIT PRÉMONTÉ		6	62x800x1600	
2		ROOF ELEMENT (RIGHT) - DACHELEMENT (RECHTE) - PANNEAU DE TOIT PRÉMONTÉ		6	62x800x1600	
		BOLT FOR WINDOW HANDLE FITTINGS - BOLZEN FÜR FENSTERGRIFF BESCHLAG - BOULON POUR POIGNÉE D'OUVERTURE DE FENETRE		4		
		SCREW FOR 1. WALL BEAM - SCHRAUBE FÜR 1. BOHLENREIHE - VIS DE FIXATION DES FONDATIONS		8	5x90	
		SCREW FOR GEORGIAN BARS - SCHRAUBE FÜR SPROSSEN - VIS DE BARRES GEORGIENNE		24	2.5x20	
		SCREW FOR FIXING ROOF ELEMENTS - SCHRAUBE FÜR BEFESTIGUNG DACHELEMENTEN - VIS DE FIXATION DES PANNEAUX DE TOIT		144	4.5x80	
		SCREW FOR ASSEMBLY BATTEN (ML) - SCHRAUBEN FÜR MONTAGELATTE (ML) - - VIS DE FIXATION DES BAGUETTES DE MAINTIEN POUR MISE EN PLACE DU TOIT (ML)		24	4x40	
		SCREW FOR EAVES BOARDS - SCHRAUBEN FÜR TRAUFBRETTER - VIS DE FIXATION POUR BANDEAU DE TOIT		18	4x40	
		SCREW FOR ASSEMBLY BATTEN - SCHRAUBEN FÜR MONTAGELATTE - VIS DE FIXATION DES BAGUETTES DE MAINTIEN POUR MISE EN PLACE DU TOIT		4	4x60	
		SCREW FOR FUNDAMENT - SCHRAUBEN ZUR BEFESTIGUNG FUNDAMENT - VIS POUR FONDATION		14	5x90	
		SCREW FOR FIXING ROOF ELEMENTS WITH RV1 - SCHRAUBE FÜR BEFESTIGUNG DACHELEMENTEN (RV1) - VIS DE FIXATION DES PANNEAUX DE TOIT (RV1)		48	5x90	
		SCREW FOR WALL FINISHING BOARD RV1 - SCHRAUBE FÜR ABSCHLUSSBOHLE RV1 - - VIS D'ASSEMBLAGE DES MADRIERS SUPÉRIEUR DE FINITION RV1		18	5x90	

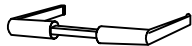
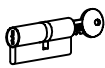
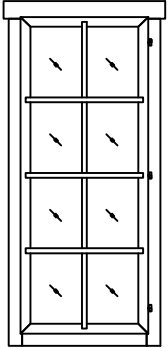
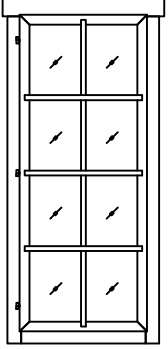
Pos	25.04.2014	Piecelist - Stücklist - Liste des composants Art.Nr. 4416005	11/11	Q.	P. (mm)	L. (mm)
		SCREW FOR DOORSTEP - SCHRAUBEN FÜR SWELLE - VIS DE FIXATION DU SEUIL DE PORTE		2	4.5x65	
		WINDOW HANDLE FITTINGS - FENSTERGRIFF - POIGNÉE D'OUVERTURE DE FENETRE		2		
		WINDOW HANDLE FITTINGS - FENSTERGRIFF - POIGNÉE D'OUVERTURE DE FENETRE		2		
		HAMMER BLOCK - SCHLAGHOLZ - CALLE DE FRAPPE		1		
		ZN NAIL FOR FLOOR - ZN NÄGEL FÜR FUSSBODENBRETTER - CLOUS POUR PLANCHER		160	2x50	
		SET OF DOOR LOCK COVERS - SCHLOSSBLENDEN - SET DE GARNITURES DE SERRURE DE PORTE		1		
		DOOR HANDLE FITTINGS - TÜRGRIF - SET DE GARNITURES DE SERRURE DE PORTE		1		
		CYLINDER LOCK - ZYLINDERSCHLOSS - CYLINDRE DE SERRURE		1	30/35	
		WINDOW - FENSTER - FENETRE 710x1674 DGP	AK.1.108.PVP.e	1		
						
		WINDOW - FENSTER - FENETRE 710x1674 DGP	AK.1.108.PVV.e	1		
						
		DOOR - TÜR - PORTE 835x1850 DGP	UK.1.108.PVP.MMa	1		
		