

*Devonshire 43*

*4413140*

*1/6*

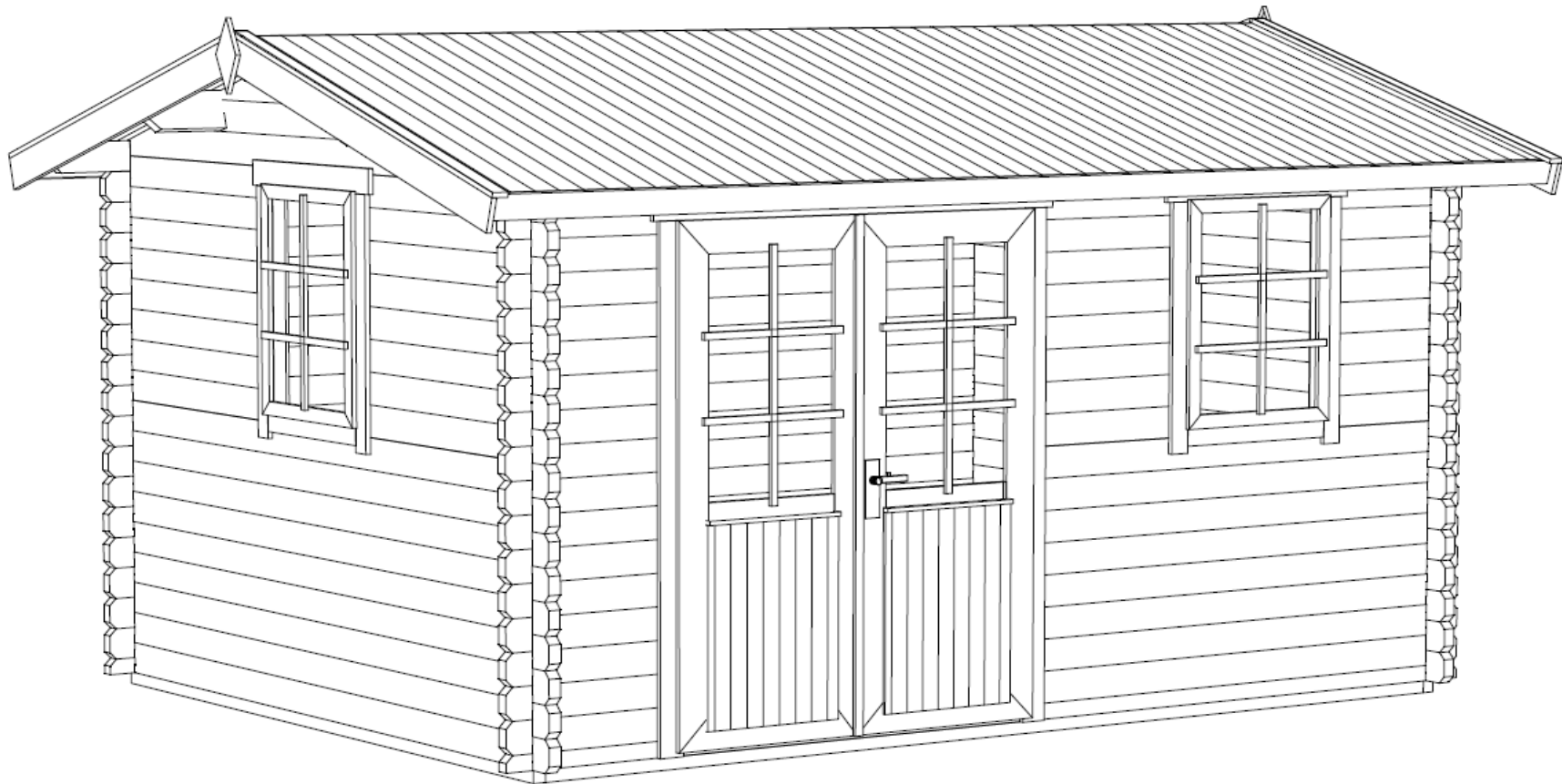

*44x114*  
*3.09.2014*

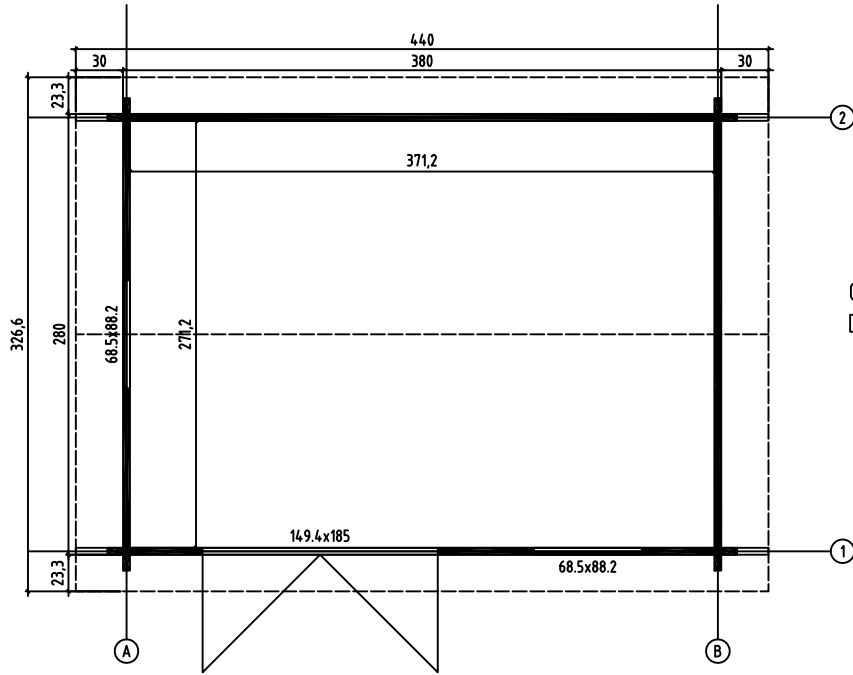

GROUNDPLAN - GRUNDPLAN - PLAN DE MASSE

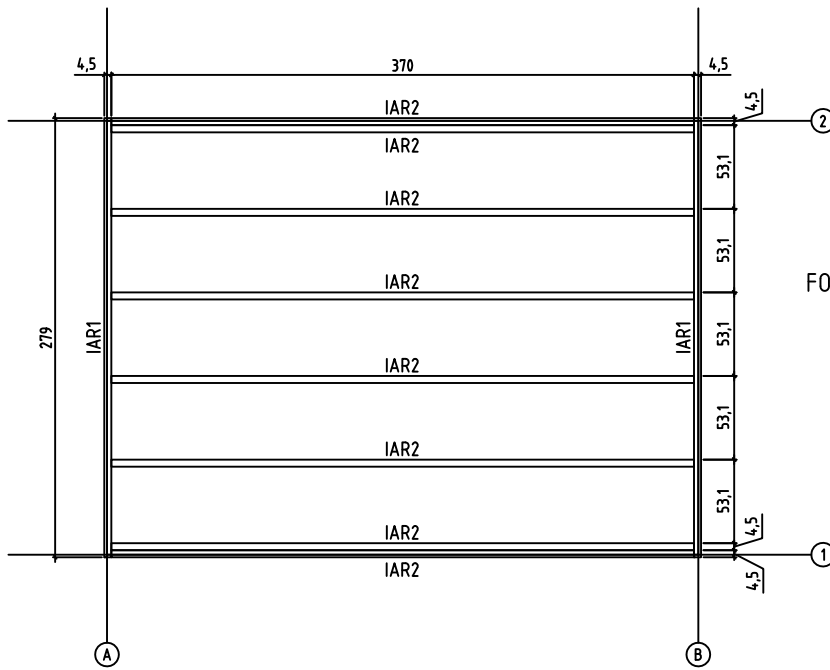



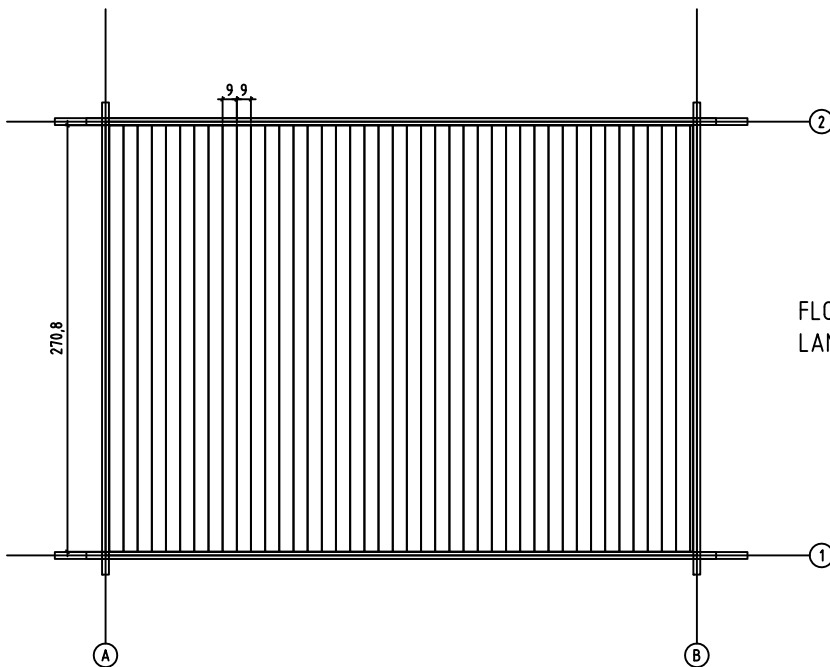



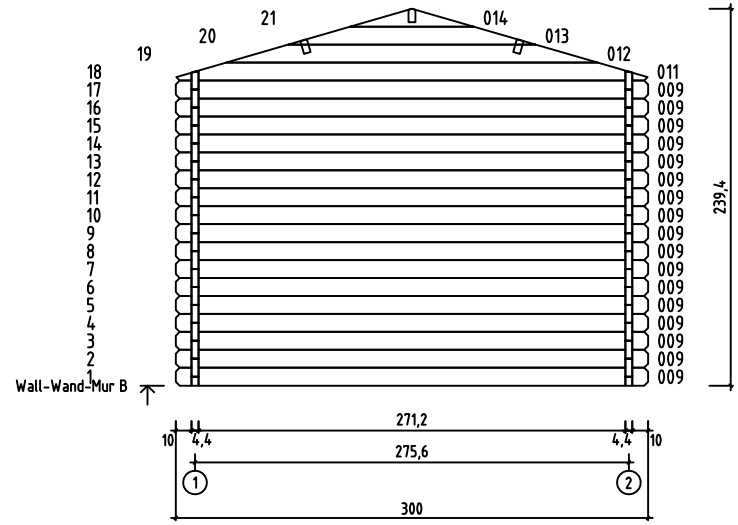
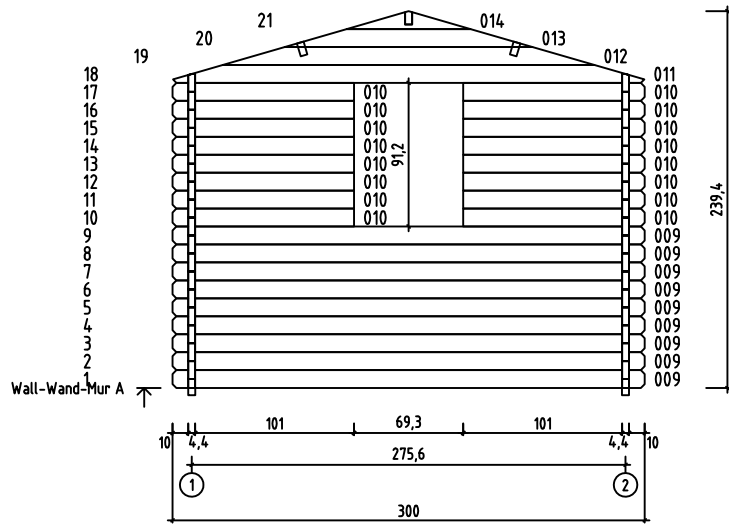
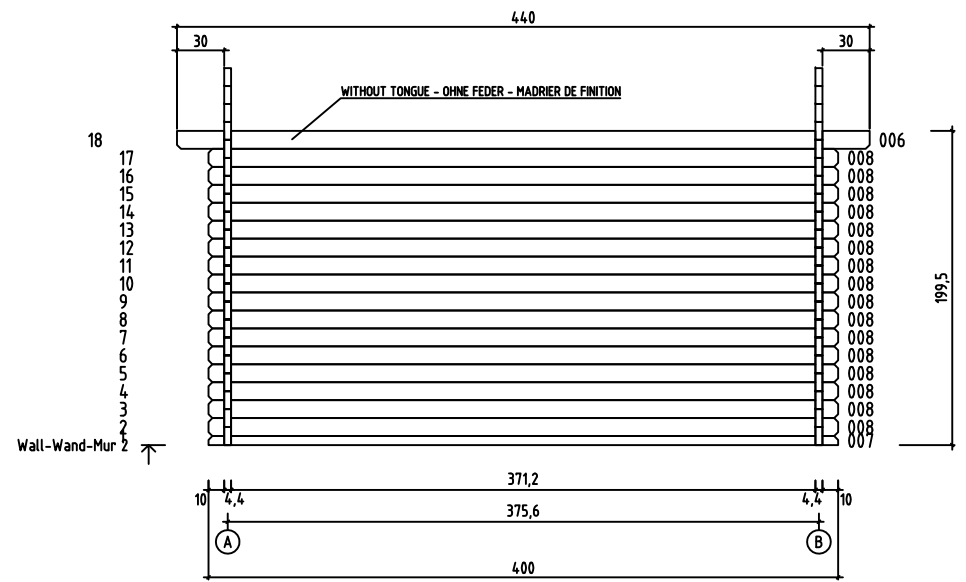
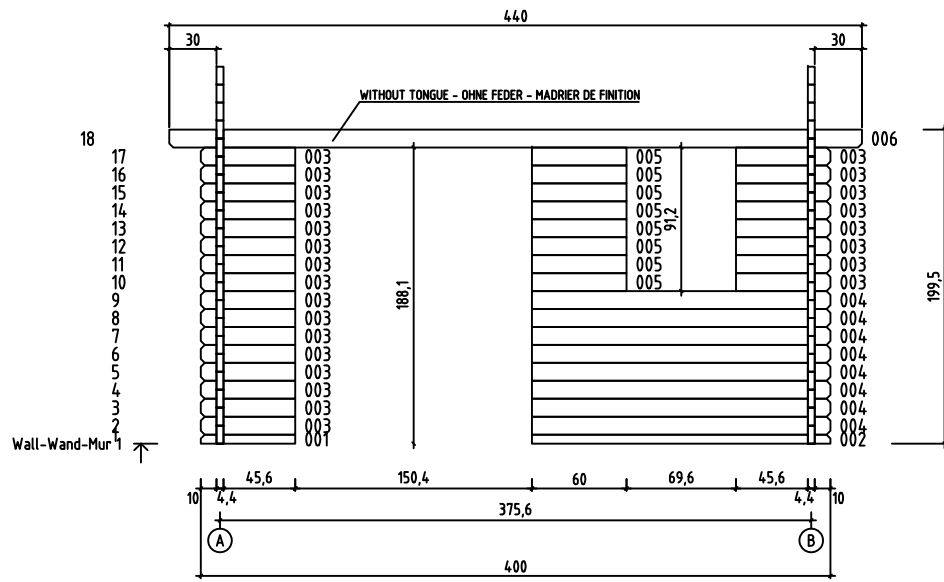

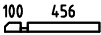
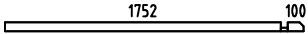
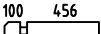
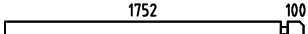

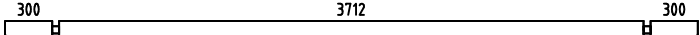
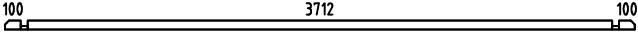
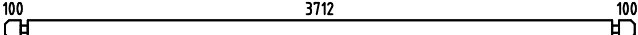
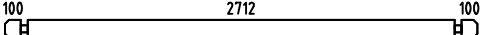
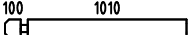
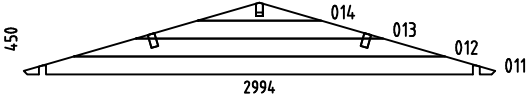
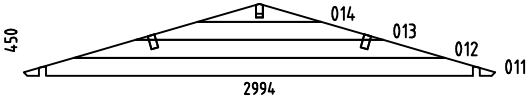

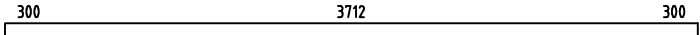
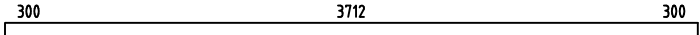





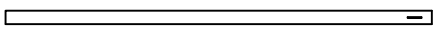
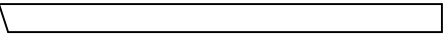

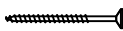
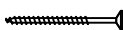

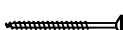





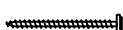

FOUNDATION - FUNDAMENT - FONDATION



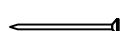

FLOOR BOARDS - FUSSBODENBRETTER - LAME DE PLANCHER

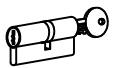
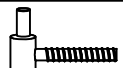

Pos	03.09.2014	Piece list - Stückliste - Liste des pièces Art. Nr. 4413140	4/6	Q.	P (mm)	L (mm)
001				1	44x57	600
002				1	44x57	1896
003				24	44x114	600
004				8	44x114	1896
005				8	44x114	600
006				2	44x120	4400
007				1	44x57	4000
008				16	44x114	4000
009				26	44x114	3000
010				16	44x114	1154
WA-1				1		
WB-1				1		
IAR1	FOUNDATION - FUNDAMENT - FONDATION 			2	45x45	2790
IAR2	FOUNDATION - FUNDAMENT - FONDATION 			8	45x45	3700
PR11	ROOF BEAM - DACHBALKEN - PANNE DE TOIT 3712 			1	44x140	4400
A.PR21	ROOF BEAM - DACHBALKEN - PANNE DE TOIT 3712 			2	44x140	4400
FB	FLOOR BOARDS - FUSSBODENBRETTER - LAME DE PLANCHER 			42	90x18	2708
DB	ROOF BOARDS - DACHBRETTER - VOLIGES 			98	90x18	1700
FL	FLOOR FILLET-FUSSBODENLEISTE - CORNIERE DE FINITION DU PLANCHER 				18x18	12.83
DPL	ROOFING FELT FILLET - DACHPAPPENLEISTE - BAGUETTE DE FIXATION DU FEUTRE BITUMEUX 			4	18x58	1750
TB	EAVES BOARD - TRAUFBRETT - BANDEAU DE TOIT 			2	18x90	4400
DRV	ROOF EDGE REINFORCEMENT - DACHRANDVERSTÄRKUNG - CORNIERE DE RENFORT DE BORD DE TOIT 			2	28x34	4400
KFS	STORM PROTECTION - STURMLEISTE - LATTE ANTI-TEMPETE 			4	22x45	1950
GL	GABLE MOULDING - GIBELLEISTE - PLANCHE DE RIVE 			4	18x120	1750

Pos	03.09.2014	Piece list - Stückliste - Liste des pièces Art. Nr. 4413140	5/6	Q.	P (mm)	L (mm)
HS88	SCREW FOR GEORGIAN BARS - SCHRAUBE FÜR SPROSSEN - VIS DE BARRES GEORGIENNE		12	2.5x20		
HS89	SCREW FOR GEORGIAN BARS - SCHRAUBE FÜR SPROSSEN - VIS DE BARRES GEORGIENNE		12	2.5x20		
HS12	SCREW FOR GABLE SEGMENT - SCHRAUBEN FÜR DECKBLATT - VIS POUR FIXATION LOSANGE DE FINITION		4	3.5x35		
HS16	SCREW FOR GABLE MOULDING - SCHRAUBEN FÜR GIEBELLEISTE - VIS DE FIXATION POUR PLANCHE DE RIVE		12	3.5x50		
HS3	SCREW FOR DOOR FILLET - SCHRAUBE ZUR BEFESTIGUNG TÜRLEISTE - VIS D'ASSEMBLAGE DU CADRE DE PORTE		5	3x30		
HS32	SCREW FOR EAVES BOARDS - SCHRAUBEN FÜR TRAUFBRETT - VIS DE FIXATION POUR BANDEAU DE TOIT		20	4x40		
HS26	SCREW FOR ROOF EDGE REINFORCEMENT - SCHRAUBEN FÜR DACHRANDVERSTÄRKUNG - VIS POUR RENFORT DE BORD DE TOIT		20	4x40		
HS43	SCREW FOR ROOF BEAMS - SCHRAUBEN FÜR DACHBALKEN - VIS POUR PANNE DE TOIT		10	5x120		
HS40	SCREW FOR 1. WALL BEAM - SCHRAUBE FÜR 1. BOHLENREIHE - VIS DE FIXATION DES FONDATIONS		8	5x90		
HS39	SCREW FOR FUNDAMENT - SCHRAUBEN ZUR BEFESTIGUNG FUNDAMENT - VIS POUR FONDATION		22	5x90		
HS41	SCREW FOR DOOR JAMB - SCHRAUBE FÜR TÜRRAHMEN - VIS DE FIXATION POUR MONTANT DE PORTE		4	5x90		
NFF	ZN NAIL FOR FLOOR FILLET - ZN NÄGEL FÜR FUSSBODENLEISTE - POINTE POUR CORNIERE DE FINITION DU PLANCHER		27	1.4x40		
SH44	HAMMER BLOCK - SCHLAGHOLZ - CALLE DE FRAPPE		1			
MS	SCREW FOR DOORSTEP - SCHRAUBEN FÜR TÜRSCHWELLE - VIS DE FIXATION DU SEUIL DE PORTE		3	4.5x65		
NFD	ZN NAIL FOR ROOFING FELT FILLET - ZN NÄGEL FÜR DACHPAPPENLEISTE - POINTE POUR BAGUETTE FIXATION FEUTRE BITUMEUX		20	2x40		
GS	GABLE SEGMENT-DECKBLATT - LOSANGE DE FINITION		2			
SFS	NUT FOR STORM PROTECTION - SCHRAUBENMUTTER FÜR STURMLEISTE - ÉCROU POUR LAME ANTI-TEMPETE		8			
BFS	BOLT FOR STORM PROTECTION - BOLZEN FÜR STURMLEISTE - VIS POUR LAME ANTI-TEMPETE		8			
DFS	WASHER FOR STORM PROTECTION - DICHTSCHEIBE FÜR STURMLEISTE - RONDELLE POUR LAME ANTI-TEMPETE		8			
NH1	ZN NAIL FOR FLOOR - ZN NÄGEL FÜR FUSSBODENBRETT - CLOUS POUR PLANCHER		258	2x50		
NH2	ZN NAIL FOR ROOF - ZN NÄGEL FÜR DACHBRETT - POINTE POUR TOIT		308	2x50		
TS3	DOOR HANDLE FITTINGS-TÜRGRIF - SET DE GARNITURES DE SERRURE DE PORTE		1			
TS4	SET OF DOOR LOCK COVERS - SCHLOSSBLENDEN - SET DE GARNITURES DE SERRURE DE PORTE		1			
TS6	CYLINDER LOCK - ZYLINDERSCHLOSS - CYLINDRE DE SERRURE		1			
TS2	MALE BOLT HINGE FOR DOOR - TÜRRIEGEL - PARTIE MALE DE CHARNIERE DE PORTE		6			

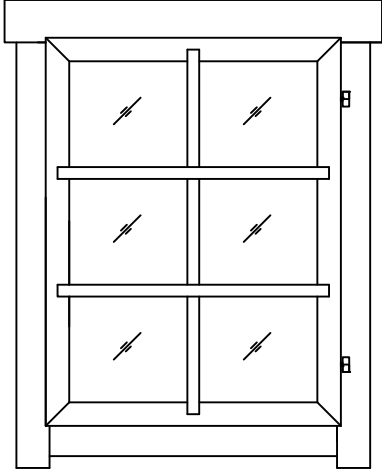
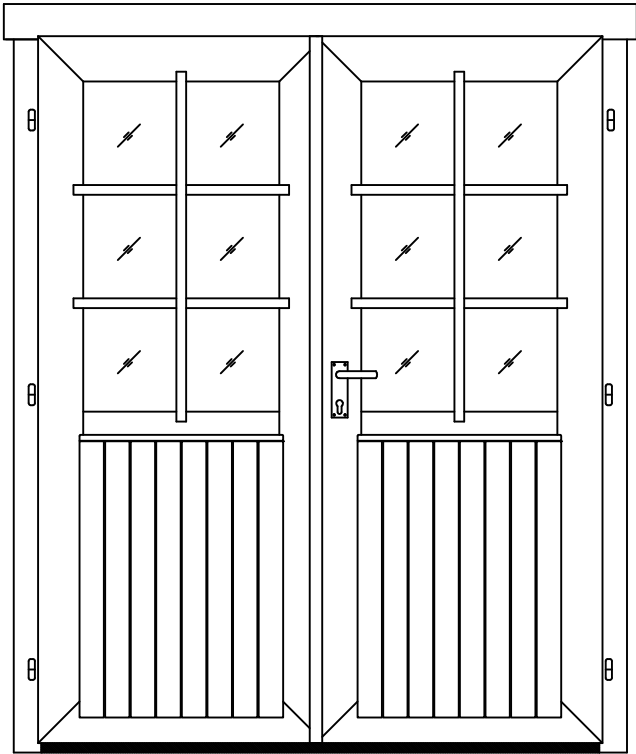
Pos	03.09.2014 Piece list - Stückliste - Liste des pièces Art. Nr. 4413140	6/6	Q.	P (mm)	L (mm)
	WINDOW HANDLE FITTINGS-FENSTERGRIFF - POIGNÉE D'OUVERTURE DE FENETRE 		2		
	BOLT FOR WINDOW HANDLE FITTINGS - BOLZEN FÜR FENSTERGRIFF BESCHLAG BOULON POUR POIGNÉE D'OUVERTURE DE FENETRE 		4		
	<p data-bbox="392 331 1054 360">WINDOW - FENSTER - FENETRE AK.1.106.PVP.d 685x882 DGP</p> 		2		
	<p data-bbox="392 1010 1038 1039">DOOR - TÜR - PORTE TUK.2.056.PVP.MMWc 1494x1850 DGP</p> 		1		