

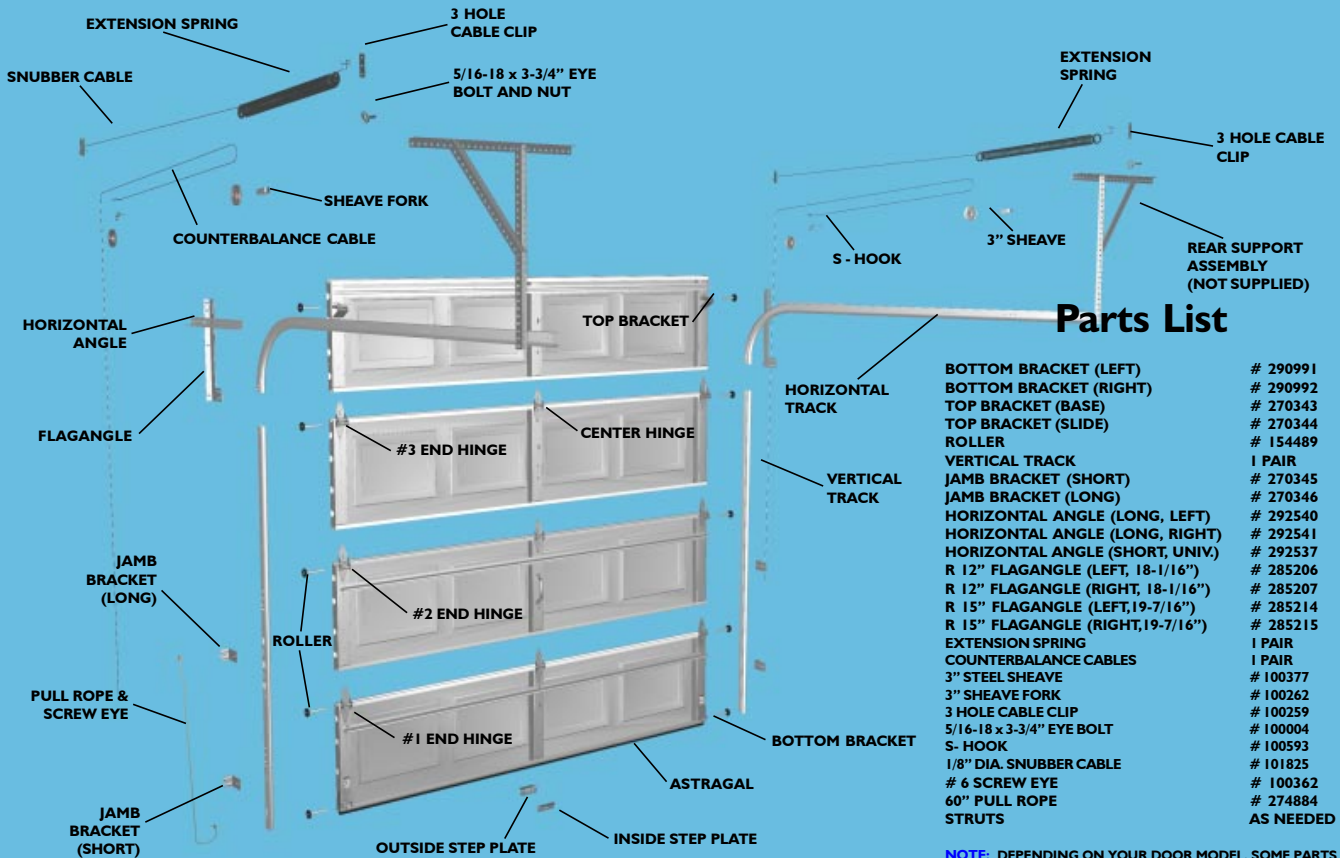

8000/8100/8200 - Extension Springs

Installation Instructions and Owners Manual



Parts List

BOTTOM BRACKET (LEFT)	# 290991
BOTTOM BRACKET (RIGHT)	# 290992
TOP BRACKET (BASE)	# 270343
TOP BRACKET (SLIDE)	# 270344
ROLLER	# 154489
VERTICAL TRACK	1 PAIR
JAMB BRACKET (SHORT)	# 270345
JAMB BRACKET (LONG)	# 270346
HORIZONTAL ANGLE (LONG, LEFT)	# 292540
HORIZONTAL ANGLE (LONG, RIGHT)	# 292541
HORIZONTAL ANGLE (SHORT, UNIV.)	# 292537
R 12" FLAGANGLE (LEFT, 18-1/16")	# 285206
R 12" FLAGANGLE (RIGHT, 18-1/16")	# 285207
R 15" FLAGANGLE (LEFT, 19-7/16")	# 285214
R 15" FLAGANGLE (RIGHT, 19-7/16")	# 285215
EXTENSION SPRING	1 PAIR
COUNTERBALANCE CABLES	1 PAIR
3" STEEL SHEAVE	# 100377
3" SHEAVE FORK	# 100262
3 HOLE CABLE CLIP	# 100259
5/16-18 x 3-3/4" EYE BOLT	# 100004
S-HOOK	# 100593
1/8" DIA. SNUBBER CABLE	# 101825
# 6 SCREW EYE	# 100362
60" PULL ROPE	# 274884
STRUTS	AS NEEDED

NOTE: DEPENDING ON YOUR DOOR MODEL, SOME PARTS LISTED MAY NOT BE SUPPLIED IF NOT NECESSARY.



Wayne-Dalton Corp.
P.O. Box 67
Mt. Hope, Ohio 44660

IMPORTANT SAFETY NOTICES

Read these instructions carefully before attempting installation. If in question about any of the procedures, do not perform the work. Instead, have a qualified door agency do the installation or repairs.

1. Wear protective gloves during installation to avoid possible cuts from sharp metal edges.
2. It is always recommended to wear eye protection when using tools, otherwise serious eye injury could result.
3. Avoid installing your new door on windy days. Door could fall during the installation and cause damage and personal injury.
4. To avoid serious injury to fingers or hands, never place fingers or hands into space between door sections when closing door. Always use pull rope or step/lift plate when manually operating door.
5. If the door is to be electrically operated at any time, all pull ropes **MUST** be removed to prevent injury or death to children who may become entangled in the rope. The locking mechanism **MUST** also be disengaged.
6. Operate door **ONLY** when properly adjusted and free of obstructions.
7. Should the door become hard to operate or completely inoperative, a qualified door agency should correct the problem to prevent damage to the door or serious personal injury.
8. **DO NOT PERMIT** children to play with the garage door or the electrical controls. Fatal injury could result, should the child become entrapped between the door and the floor.
9. To prevent serious injury or death, avoid standing in the open doorway or walking through the doorway while the door is moving.
10. Door is constantly under **EXTREME SPRING TENSION**. To prevent possible serious injury or death, adjustments, repairs, removal or installation, **ESPECIALLY** of **SPRING ASSEMBLIES, CABLES** or **BOTTOM CORNER BRACKETS**, should be performed **ONLY** by qualified door service people.
11. If your existing garage door opener does not have a reversing mechanism, you should consider purchasing one that has up to date safety features. These features can prevent opener related property damage or personal injury.
12. Check all bolted connections monthly during the lifetime of the door to prevent damage or personal injury caused by loose connections.

Definition of key words used in this manual:

 **WARNING!** -- Indicates a potentially hazardous situation which, if not avoided, could result in serious injury or death.

IMPORTANT! -- Required step for safe and proper door operation.

NOTE: -- Information assuring proper installation of the door.

MAINTENANCE AND PAINTING INSTRUCTION FOR PREPAINTED STEEL DOORS

MAINTENANCE

While factory-applied finishes for steel garage doors are so durable that they will last many years longer than ordinary paints, it is desirable to clean them thoroughly on a routine basis. Apparent discoloration of the paint may occur when it has been exposed in dirt-laden atmospheres for long periods of time. Slight chalking may also cause some change in appearance in areas of strong sunlight. A good cleaning will generally restore the appearance of these coatings and render repainting unnecessary. An occasional light cleaning will also help maintain an aesthetically pleasing appearance. To maintain the original finish of the garage doors, the only regular maintenance necessary is that of annual washing. Mild solutions of detergents or household ammonia will aid in the removal of most dirt, and the following are recommended levels:

One cup of Tide™, or other common detergents, which contain less than 0.5% phosphate, dissolved into five gallons of warm water. NOTE: The use of detergents containing greater than 0.5% phosphate is not recommended for use in general cleaning of garage doors. CAUTION: NEVER MIX CLEANSERS OR DETERGENTS WITH BLEACH.

SURFACE PREPARATION FOR PAINTING

Wax on the surface must be removed or paint peeling/flaking will result. To remove this wax, it will be necessary to lightly scuff the surface with a gray (not green!) 3M ScotchBrite pad saturated with soapy water. A final wipe and rinse should be done with clean water only, to remove any loose dust or soap film.

Surface scratches, which have not exposed the metal substrate, can be lightly buffed or sanded with 0000 steel wool or No. 400 sand paper to create a smoother surface. Care must be taken to not expose the substrate under the paint (see Note No. 2). Once this exposed condition exists, the likelihood for rusting is greatly increased. See the following paragraph if the metal substrate is observed.

Exposed substrate must be treated to prevent rust from forming (see Note No. 2). Sand the exposed area lightly and paint with high quality metal primer to protect from corrosion. Follow drying time on primer can label before applying topcoat.

The surface to be recoated must not be too smooth or the repaint material will not adhere to it (see Note No. 2). It is advisable to test a representative area to evaluate adhesion. If poor adhesion is observed, the surface must be abraded by sanding or buffing using grades mentioned above. Care must be taken to not expose the substrate under the paint.

PAINTING

After the surface has been properly prepared it must be allowed to dry thoroughly, then coated immediately with a premium quality latex house paint. Follow the paint label directions explicitly. Oil base paint is not recommended. Please note that if substrate is exposed, painting with latex paint may cause accelerated rusting of steel.

NOTES:

1. Repainting of finish painted steel doors cannot be warranted as this condition is totally beyond door manufacturer's control.
2. If the steel door surface has a finish painted textured surface representing wood grain, stucco, etc., this step should not be attempted as danger of exposing substrate is greatly increased.
3. Consult a professional coatings contractor if in doubt about any of the above directions.
4. Follow directions explicitly on the paint and solvent container labels for proper applications of coatings and disposal of containers. Pay particular attention to those directions involving acceptable conditions in which to paint.

IMPORTANT!
DOOR OPENING PREPARATION IS CRITICAL FOR PROPER DOOR INSTALLATION. REFER TO INSERT SHEET "PREPARING THE OPENING" BEFORE INSTALLING NEW DOOR.

IMPORTANT!
JAMBS, HEADER AND SPRING PAD MUST BE SECURELY ATTACHED TO FRAMING MEMBERS. CHECK BEFORE INSTALLING NEW DOOR.

IMPORTANT!
BACK HANGER ASSEMBLIES MUST BE SECURELY ATTACHED TO CEILING FRAMING MEMBERS ADEQUATE TO HOLD THE WEIGHT OF THE DOOR.

IMPORTANT!
IF INSTALLING A REPLACEMENT DOOR, CHECK THE OPENING SIZE AND NEW DOOR SIZE, MAKING SURE THEY MATCH BEFORE REMOVING EXISTING DOOR.

NOTE:
SINGLE WIDE DOOR SHOWN IN ILLUSTRATION. (STRUTS NOT SUPPLIED ON SINGLE WIDE DOORS)

2" STEEL STRUT (DOORS 14' TO 18' WIDE)
3" STEEL STRUT (DOORS 18'-1" TO 20' WIDE)

NOTE:
DOORS WITH OPERATORS, SEE STEP 18

NOTE: SIDE LOCK INSTALLATION OPTIONAL

SIDE LOCK INSTALLATION
INSTALLATION IS ON SECOND SECTION OF DOOR. SECURE THE LOCK TO THE SECTION WITH (4) 1/4-20 X 5/8" SELF DRILLING SCREWS. SQUARE LOCK ASSEMBLY WITH DOOR SECTION AND HOLE IN VERTICAL TRACK. THE SIDE LOCK SHOULD BE SPACED APPROX. 1/8" FROM THE SECTION EDGE.

IMPORTANT! IT IS RECOMMENDED THAT SIDE LOCKS BE REMOVED IF AN OPERATOR IS INSTALLED ON THE DOOR.

2" STEEL STRUT (DOORS 16'-1" TO 18' WIDE)
3" STEEL STRUT (DOORS 18'-1" TO 20' WIDE)

2" STEEL STRUT (DOORS 16'-1" TO 18' WIDE, OR 14' TO 16' WIDE, 5 SECTION HIGH DOOR)
3" STEEL STRUT (DOORS 18'-1" TO 20' WIDE)

8000/8100/8200 STRUTTING SCHEDULE

Door Width	4 section	5 section
8'-0" to 13'-11"	Not Required	Not Required
14'-0" to 16'-0"	(1) 2" U-bar	(2) 2" U-bars
16'-1" to 18'-0"	(3) 2" U-bars	(3) 2" U-bars
18'-1" to 20'-0"	(4) 3" U-bars	(5) 3" U-bars

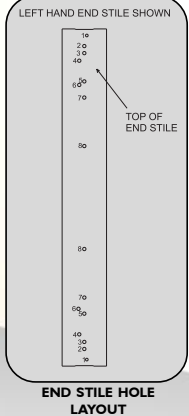

12

11

10

1

2

13

14 - 15

9

3" STEEL STRUT (DOORS 18'-1" TO 20' WIDE)

7

5

8

3

16

4

17

6

START HERE

IMPORTANT! READ IMPORTANT SAFETY NOTICES AND REFER TO INSERT SHEET INSTRUCTIONS TITLED "REMOVING THE OLD DOOR/PREPARING THE OPENING". IF THE INSERT SHEET INSTRUCTIONS ARE NOT INCLUDED, CONTACT WAYNE-DALTON CORP. FOR A FREE COPY.

If removing an existing door, carefully follow the directions given on the insert sheet instruction in the portion titled "Removing the Old Door".

⚠️ WARNING!

REMOVAL OF AN EXISTING DOOR CAN BE DANGEROUS. FOLLOW INSERT SHEET INSTRUCTIONS CAREFULLY, OTHERWISE SERIOUS INJURY OR DEATH COULD RESULT.

Begin the installation of the door by checking the opening. It must be the same size as the door. Vertical jamba must be plumb and the header level. Side clearance, from edge of door to wall, must be minimum of 3-1/2" (89 mm) on each side. For proper opening preparation refer to the portion of the insert sheet instructions titled "Preparing the Opening".

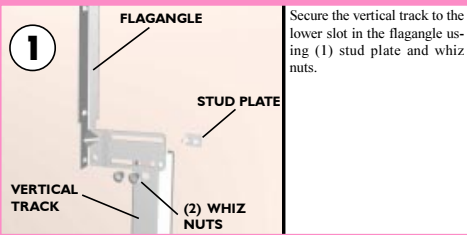

Secure the vertical track to the lower slot in the flagangle using (1) stud plate and whiz nuts.

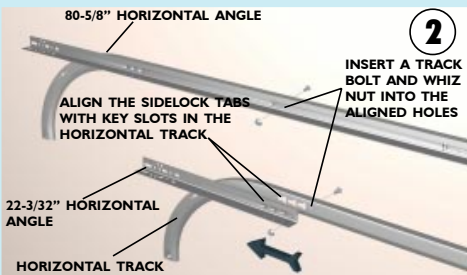

Align the Sidelock™ tabs on the applicable horizontal angle with key slots in the horizontal track. Push the parts together. Using a hammer, tap the horizontal angle towards the curved end of the track until the hole in track and angle are aligned. Set track aside.

NOTE: For larger size doors, a full length horizontal angle is already spot welded to the horizontal track.

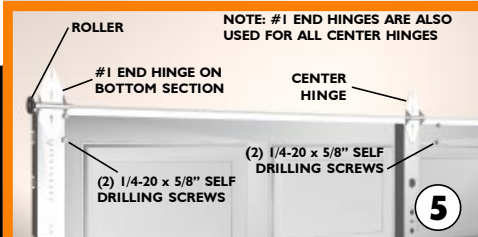

NOTE: #1 END HINGES ARE ALSO USED FOR ALL CENTER HINGES

Locate the lower (numbered) leaf of the #1 end hinges and required center hinges over the pre-punched holes in the end stiles and center stile(s) at the top of the bottom section. Secure the hinges to the section using (2) 1/4-20 x 5/8" self tapping, torque limiting screws each. Repeat for all other sections using the #2 end hinges on the second or lock section and the #3 end hinges on the third section.

NOTE: #4 End hinges are used on fourth section of five section doors.

NOTE: Bottom section can be identified by the factory attached bottom astragal.

IMPORTANT! When placing rollers into end hinges number 2 and higher, the roller goes into tube furthest away from section.

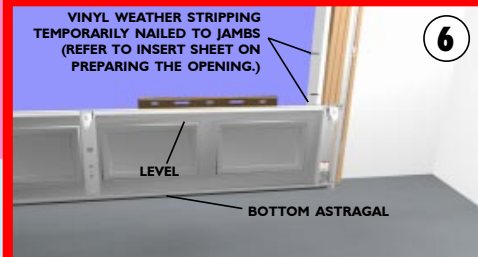

Before installing the bottom section, measure and cut vinyl jamb weatherstripping (not included) for entire garage door opening. Vinyl weather seal must be installed prior to door installation. Attach the weather seal to the door jamb 1/8" to 1/4" past door jamb (see figure below). Temporarily nail the weatherstripping to the door jambs and header. This will help hold the bottom door section in place. Refer to the insert sheet on preparing the opening. **Now comes the single most important step in installing the Wayne-Dalton garage door system.** Center the bottom section in the door opening. Level it using wooden shims under the bottom astragal as needed. Once the bottom section is level, all the other components will automatically align. Hold the section in the opening while attaching vertical tracks.

NOTE: In the event that the bottom section was shimmed to level it, then the vertical track on that same side of the section must be raised the thickness of the shim(s). The tops of the vertical track must be level.

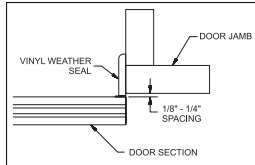

Align upper-center hole of top bracket with #7 hole in the end stile (See Endstile Hole Layout). Secure with (1) 1/4-20 x 5/8" self tapping screw. Ensure top bracket is level and aligned with edge of section. Secure with (2) 1/4-20 x 5/8" self drilling screws, one in each bottom corner of the top bracket. Loosely fasten top bracket slide with 1/4-20 x 5/8" carriage bolt and nut. Insert roller and repeat for other side.

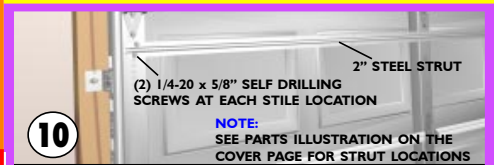
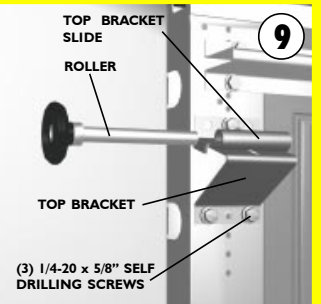

2" steel struts are required on all doors 14" wide and over. (SEE PARTS ILLUSTRATION ON THE INSIDE COVER PAGE FOR STRUT QUANTITIES AND LOCATIONS.) Center the strut side to side on the section at the location shown, and secure the strut to the section using (2) 1/4-20 x 5/8" self drilling, torque limiting screws at each end and center stile location. Place the top section in the door opening and secure it temporarily by driving a nail into the header near the center of the door and bending it over the section. Now flip, hold, and fasten the hinges.

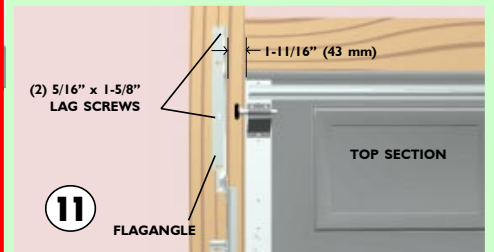

Position flagangle 1-11/16" (43 mm) from the edge of the door. Tighten the first lag screw then secure flagangle to the jamb with 2 more 5/16" x 1-5/8" lag screws. Now complete the vertical track installation on both sides by securing the center jamb bracket and tightening other lag bolts.

IMPORTANT! Vertical tracks must be secured so that the rollers are touching the deepest part of the curved side of the track.

IMPORTANT! Ensure that flagangles are parallel with door sections.

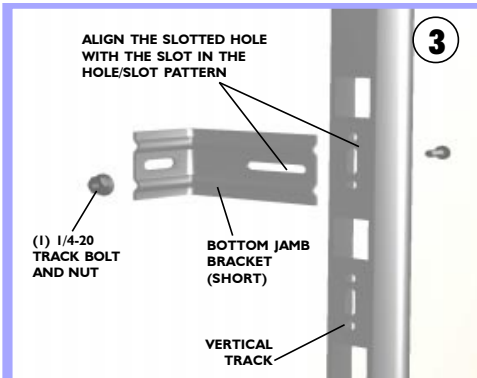

To attach the bottom jamb bracket, locate the lower hole/slot pattern in the vertical track. Align the slotted hole with the hole slot pattern of the vertical track and secure to track using (1) 1/4-20 x 9/16" track bolt and nut. Place the center jamb bracket over the hole/slot pattern nearest to the center of the track. Loosely fasten the bracket onto the track with (1) 1/4-20 x 9/16" track bolt and nut.

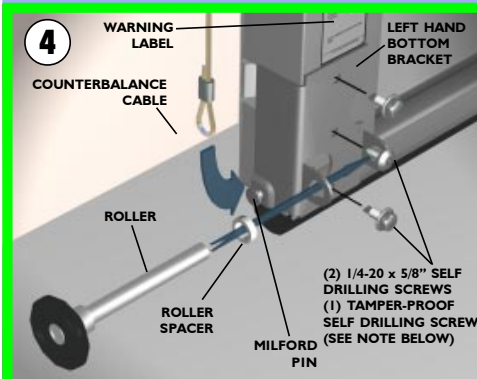

Align top two holes of bottom bracket with #3 and #5 holes in endstiles of the bottom section. Secure the bottom bracket using (2) 1/4-20 x 5/8" self drilling screws and (1) Tamper-proof self drilling screw. Secure counterbalance cable loops over milford pins.

NOTE: Only doors provided to professional installers, who have required tools will be supplied with a tamper-proof fastener. Use a (3) 1/4-20 x 5/8" self drilling screws in bottom bracket, if not provided with a tamper-proof screw.

IMPORTANT! Right and left hand is always determined from inside the building looking out.

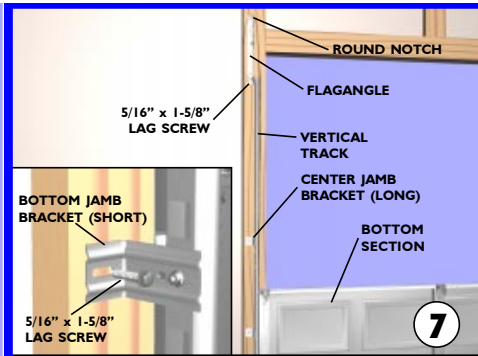

Position the vertical track over the rollers of the bottom section. Make sure the counterbalance cable is located between the rollers and the door jamb. Loosely fasten bottom jamb bracket and flagangle with (1) 5/16" x 1-5/8" lag screw each, but do not install a lag screw into the center jamb bracket yet. Run the counterbalance cable up between vertical track and edge of door section. Hang the cable over the top of the flagangle in round notch. Repeat for other side.

IMPORTANT! The tops of the vertical tracks must be level from side to side.



Make sure top leaves of all hinges on the bottom section are folded down. Insert rollers into the end hinges of the second section (also referred to as lock section). With assistance lift section and place rollers over the tops of the vertical tracks. Install by guiding rollers into the vertical track on both sides and gently lowering this section onto the bottom section. Keeping the ends of the sections aligned, install remaining section(s), except top section, in same manner. Fasten all hinges to connect the sections by flipping up the hinge leaf, holding it firmly against section and driving in the supplied 1/4-20 x 5/8" torque limiting screws.

NOTE: To install lock, see lock instructions included in the lock assembly bag.

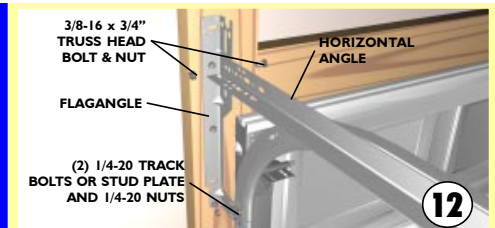

(IMPORTANT!) The dimension between the flagangles must be exactly door-width plus 3-3/8" (86 mm) for smooth, safe door operation.

To install horizontal track, place the curved end over the top roller. Align the bottom of the horizontal track with the top of vertical track. Secure the track to the flagangle with (2) 1/4-20 track bolts or (1) stud plate and nuts. Bolt the reinforcing angle to the slot in the flagangle using (1) 3/8-16 x 3/4" truss head bolt and nut. Repeat for other side. With tracks installed you can adjust the top brackets. Vertically align the top section with the lower sections. Once aligned, position top roller in adjustable slide against horizontal track to maintain position and tighten nut(s). Repeat for other side. Remove the nail from above the top section. **(IMPORTANT!)** Failure to remove nail before attempting to raise door could cause permanent damage to top section.)

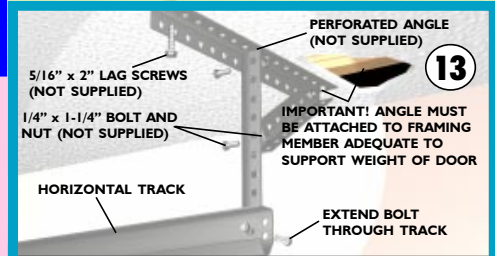

With assistance, raise door until the top section and half of the next section are in a horizontal position. Do not raise door any further since rear of horizontal track is not yet supported.

WARNING! RAISING DOOR FURTHER CAN RESULT IN DOOR FALLING AND CAUSE SEVERE INJURY OR DEATH.

Hold door in position and clamp locking pliers to vertical track on each side just below bottom rollers. This will prevent door from lowering. Using perforated angle, fabricate rear support for horizontal tracks as shown. Using lag bolts, make sure that support is fastened into ceiling joist, or adequate framing members to hold the weight of the door. Keeping the horizontal track parallel to the edge of the door sections, raise the horizontal track to a level position and bolt it to the rear support structure. Track must be secured and braced to prevent movement. The bolt should extend into the track to act as a roller stop. Repeat for other side.

WARNING! KEEP HORIZONTAL TRACK PARALLEL AND WITHIN 3/4" OF DOOR EDGE, OTHERWISE DOOR COULD FALL FROM TRACKS, RESULTING IN SERIOUS INJURY OR DEATH.

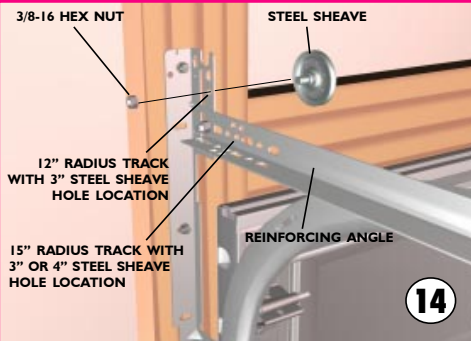

Using (1) 3/8" - 16 hex nut, attach the front steel sheave in the appropriate hole. Repeat for other side.
3" Steel Sheave with 12" radius track - Bolt the sheave to the 13/32" hole in the top of the flagangle.
3" Steel Sheave with 15" radius track - Bolt the sheave to the first 13/32" hole in the horizontal angle using (2) washers.
4" Steel Sheave with 12" or 15" radius track - Bolt the sheave to the first 13/32" hole in the horizontal angle using (1) washer.

Remove the locking pliers from the vertical tracks and with assistance raise the door slowly into the open position making sure the door travels smoothly through the track. Clamp locking pliers to the bag leg of both horizontal tracks, below the bottom rollers to keep the door from falling.

DOORS FEATURING 2 PAIRS OF EXTENSION SPRINGS

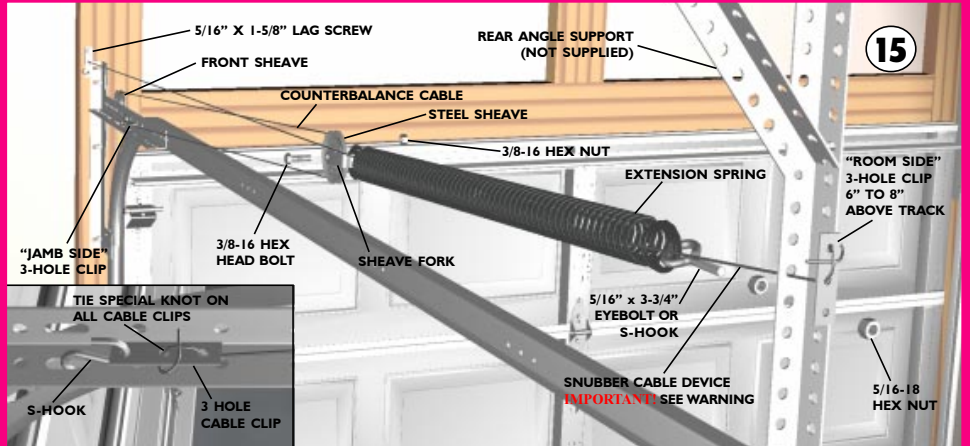
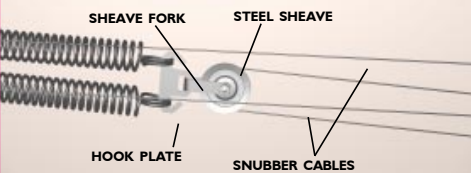

Position the (1) 5/16" - 18 x 3-3/4" eyebolt and (1) 5/16" - 18 hex nut in the rear support, 6" to 8" above the horizontal track. Feed the snubber cable through the rear support and tie the special knot around the "room side" 3 hole clip as shown. Secure the eyebolt and clip to the rear support with (1) 5/16" - 18 hex nut. Hook one end of the extension spring onto the eyebolt. Feed the snubber cable through the end spring loop and center of the extension spring then front spring loop, pull the snubber cable taut and tie the special knot around the "jamb side" 3 hole clip. Attach the "jamb side" 3 hole clip to the jamb near the flagangle with (1) 5/16" x 1-5/8" lag bolt. If springs are attached to rear support with "S" hooks instead of eyebolts, then "Room Side" 3 Hole clip is attached to rear support with 1/4"-20 x 5/8" machine bolt and nut.

NOTE: Adjust snubber cables to be taut.

WARNING
FAILURE TO CLOSE "S" HOOKS AND EYE BOLTS CAN RESULT IN SEVERE INJURY OR DEATH IN CASE SPRINGS COME LOOSE.

Hook the sheave fork through the front loop of the extension spring and attach the sheave fork to the rear 3" steel sheave using (1) 3/8" - 16 x 1-1/4" bolt and nut. Thread the counterbalance cable over the front sheave, around the rear sheave and tie the special knot around the "horizontal angle" 3 hole clip. Insert one end of the large "S" hook in the "horizontal angle" 3 hole clip and the other end in the second slot of the horizontal angle. Close "S" hook and eye bolt to prevent spring(s) from coming loose. Repeat for the other side.

IMPORTANT! Close "S" hooks and eye bolts to prevent springs from coming loose.

WARNING
FAILURE TO INSTALL SNUBBER CABLES CAN RESULT IN SEVERE INJURY OR DEATH IN CASE OF SPRING BREAKAGE.

NOTE: Some larger doors feature 2 pairs of extension springs. A snubber cable must be installed through each spring

Adjust counterbalance cables to create about 1" to 2" (25 mm to 50 mm) of spring stretch. Measure relaxed spring length for your door height and verify with chart. Spring length must be the same for both springs to allow even door balance. Carefully remove the locking pliers from the horizontal track and lower the door into the closed position. Once the door is closed, measure the spring length in tension for both sides. Using the chart, verify the spring length in tension is correct with your door height.

NOTE: It may be necessary to adjust spring length for proper door balance.

Permanently attach the vinyl weather stripping to both door jambs and the header. Now lift the door and check it's balance. If the door is hard to pull down or lifts by itself, adjust spring length by moving the "S" hook backward (towards the rear support) to a different hole in the reinforcing angle. If the door is difficult to lift or too easy to pull down, adjust spring length by moving the "S" hook forward (towards the header) to a different hole in the reinforcing angle.

IMPORTANT! Whenever adjusting spring length for door balance, always open the door to the fully open position and return the locking pliers to the horizontal tracks below the bottom rollers.

If the door still does not operate easily, lower the door into the closed position and recheck the following items:

- 1.) Check the door for level.
- 2.) Check the distance between flagangles - must be door width plus 3-3/8" + 1/4" - 0".
- 3.) Check the counterbalance cables for equal tension - adjust by re-tying the special knot.

EXTENSION SPRING LENGTH CHART

DOOR HEIGHT	SPRING LENGTH RELAXED (DOOR OPEN)	SPRING LENGTH EXTENDED (DOOR CLOSED)
6' - 5"	25" - 27" (635 mm - 686 mm)	63.5" - 65.5" (1613 mm - 1664 mm)
6' - 6"	25" - 27" (635 mm - 686 mm)	64" - 66" (1626 mm - 1676 mm)
7' - 0"	25" - 27" (635 mm - 686 mm)	67" - 69" (1702 mm - 1753 mm)
7' - 6"	27" - 29" (686 mm - 737 mm)	72" - 74" (1829 mm - 1880 mm)
8' - 0"	27" - 29" (686 mm - 737 mm)	75" - 77" (1905 mm - 1956 mm)



8000/8100/8200

LIMITED WARRANTY

The Manufacturer warrants the 8000, 8100, and 8200 Garage Doors for a period of ten (10) years, from the time of installation, against section rust through due to the exterior paint finish cracking, checking or peeling. The manufacturer will replace or restore (our option) any such defective garage door sections. This warranty does not extend to paint applied over the factory finish. Other conditions and exceptions as contained herein apply.

The Manufacturer warrants the garage door hardware and track, excluding springs, against defect in workmanship or material for a period of ten (10) years from time of installation.

This warranty extends to the original homeowner, providing the door is installed in his/her place of primary residence. It is not transferable. The warranty applies to residential property only and is not valid on commercial or rental property.

The Manufacturer warrants that any parts of the door not covered by the above limited warranty will be free from defects in workmanship and material for ONE YEAR from the time of installation.

The Manufacturer shall, upon notification, correct such nonconformity at its option, by repairing, replacing, or refunding original purchase price of any defective part(s). This warranty covers material only and excludes all other charges incurred.

NO EMPLOYEE, DISTRIBUTER, OR REPRESENTATIVE IS AUTHORIZED TO CHANGE THE FOREGOING WARRANTIES IN ANY WAY OR GRANT ANY OTHER WARRANTY ON BEHALF OF MANUFACTURER.

The Manufacturer shall not be responsible for any damage resulting to or caused by its products by reason of installation, improper storage, unauthorized service, alteration of products, neglect or abuse, or attempt to use the products for other than the customary usage or for their intended purposes. This warranty does not cover normal wear or any damage beyond Manufacturer's control or replacement labor.

THIS WARRANTY COVERS A CONSUMER PRODUCT AS DEFINED BY THE MAGNUSON-MOSS WARRANTY ACT. NO WARRANTIES, EXPRESSED OR IMPLIED, (INCLUDING BUT NOT LIMITED TO, THE WARRANTY OF MERCHANTABILITY OR FITNESS FOR A PARTICULAR PURPOSE), SHALL EXTEND BEYOND THE APPLICABLE TIME PERIOD STATED IN BOLD FACE TYPE ABOVE.

Claims for defects in material and workmanship covered by this warranty shall be made in writing to the dealer from whom the product was purchased within the warranty period. Manufacturer may either send a service representative or have the product returned to the Manufacturer at Buyer's expense for inspection. If judged by Manufacturer to be defective in material or workmanship, the product will be replaced or repaired at the option of Manufacturer, free from all charges except authorized transportation and replacement labor.

THE REMEDIES OF BUYER SET FORTH HEREIN ARE EXCLUSIVE AND ARE IN LIEU OF ALL OTHER REMEDIES. THE LIABILITY OF MANUFACTURER, WHETHER IN CONTRACT, TORT, UNDER ANY WARRANTY, OR OTHERWISE, SHALL NOT EXTEND BEYOND ITS OBLIGATION TO REPAIR OR REPLACE, AT ITS OPTION, ANY PRODUCT OR PART FOUND BY MANUFACTURER TO BE DEFECTIVE IN MATERIAL OR WORKMANSHIP. MANUFACTURER SHALL NOT BE LIABLE FOR COST OF REMOVAL OR INSTALLATION OR SHALL NOT BE RESPONSIBLE FOR ANY DIRECT, INDIRECT, SPECIAL OR CONSEQUENTIAL DAMAGES OF ANY NATURE.

This warranty gives you specific legal rights and you may also have other rights, which may vary from state to state. However, some states do not allow limitations on how long an implied warranty lasts or the exclusion or limitation of incidental or consequential damages, so the above limitations or exclusions may not apply to you.

Yearly maintenance as described in the Maintenance and Painting Instructions for Prepainted Steel Doors is required. Should you need an additional copy, contact your local authorized Wayne-Dalton distributor.

© Copyright 2002 Wayne-Dalton Corporation

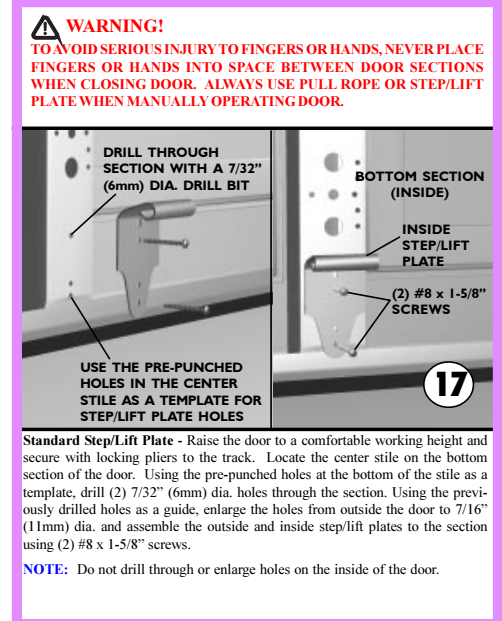
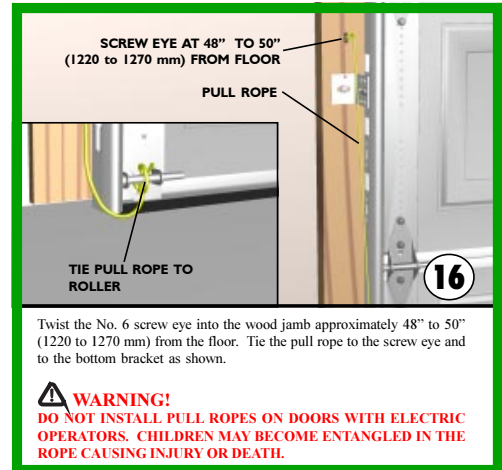

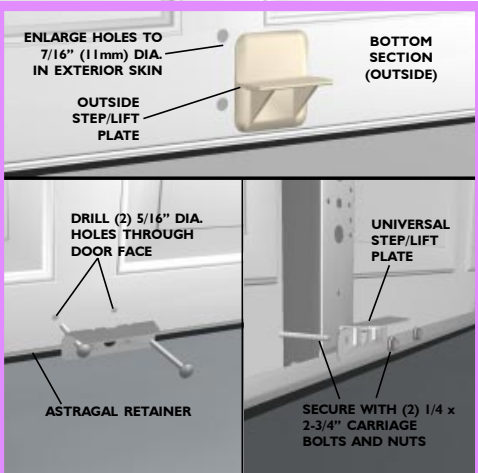

Universal Step/Lift Plate - Attach step plate to center-most stile of bottom section. Position step/lift plate directly above astragal retainer. Using the step/lift plate as a template, mark hole locations for mounting on door face. Drill 5/16" dia. holes through door face and insulation if necessary, being careful to keep drill straight. Mount step/lift plates back to back, straddling stile. Secure with (2) 1/4 x 2-3/4" carriage bolts and nuts.

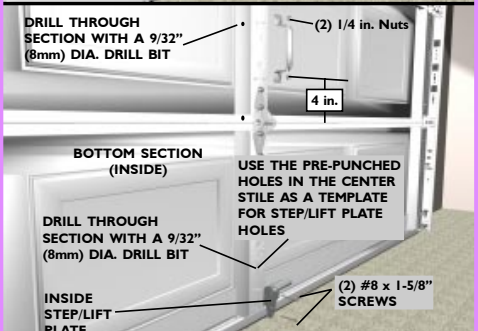
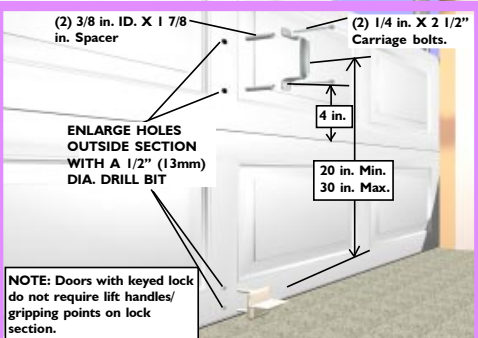

Standard Lock Section Lift Handle/Gripping Point - (NOTE: Doors with Keyed lock do not require this lift handle.) Raise the door to a comfortable working height and secure with locking pliers to the track. Locate the inside center stile or the desired lift handle location on the lock (2nd) section of the door. Measure up 4 inches from the bottom of the second section. Using this measurement as a guide, position lift handle bottom hole and make a mark at the top hole in lift handle. This should give you a Min. of 20 in. and a Max. of 30 in. between the lower lift handle/gripping point and the middle of the upper lift handle/gripping point. If needed reposition upper lift handle to stay within Min. and Max. dimension. Drill two 9/32 in.(8mm) dia. holes through section. Enlarge the holes from outside the door to 1/2" (13mm) dia. (NOTE: Do not drill through or enlarge holes on the inside of the door.) Assemble the outside and inside lift handle/gripping points to the section using (2) 1/4" x 2 1/2" carriage bolts and nuts and (2) Spacers.

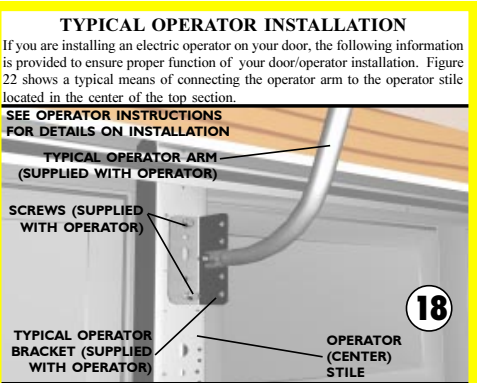

- INSTALLATION TIPS:**
1. Follow the installation instructions supplied with your operator.
 2. Reinforce top section per manufacturer's recommendation prior to attaching operator.
 3. Install trolley rail 1" to 1-1/2" (25 - 38 mm) above high arc of top section of the door.
 4. Mount operator to ceiling so that 1" to 1-1/2" (25 - 38 mm) clearance is maintained between trolley rail and top section when door is fully open (trolley rail will slope down towards rear).

WARNING!
OPERATOR MUST BE TESTED AT TIME OF INSTALLATION AND MONTHLY THEREAFTER TO ENSURE THAT DOOR REVERSES ON CONTACT WITH 2 X 4 BOARD LAID FLAT UNDER THE DOOR. FAILURE TO ADJUST OPERATOR, IF NECESSARY, CAN RESULT IN SEVERE INJURY OR DEATH. IF YOUR OPERATOR IS EQUIPPED WITH PHOTOELECTRIC SYSTEM, THEN THIS MUST BE TESTED AT THE SAME TIME TO ENSURE THAT DOOR DOES NOT CLOSE AND A CLOSING DOOR OPENS IF SYSTEM IS OBSTRUCTED. FAILURE TO MAKE ADJUSTMENTS, IF NECESSARY, CAN RESULT IN SEVERE INJURY OR DEATH.

