

*Warwickshire 53*  
*Art. Nr. 4413040*  
*1/8*

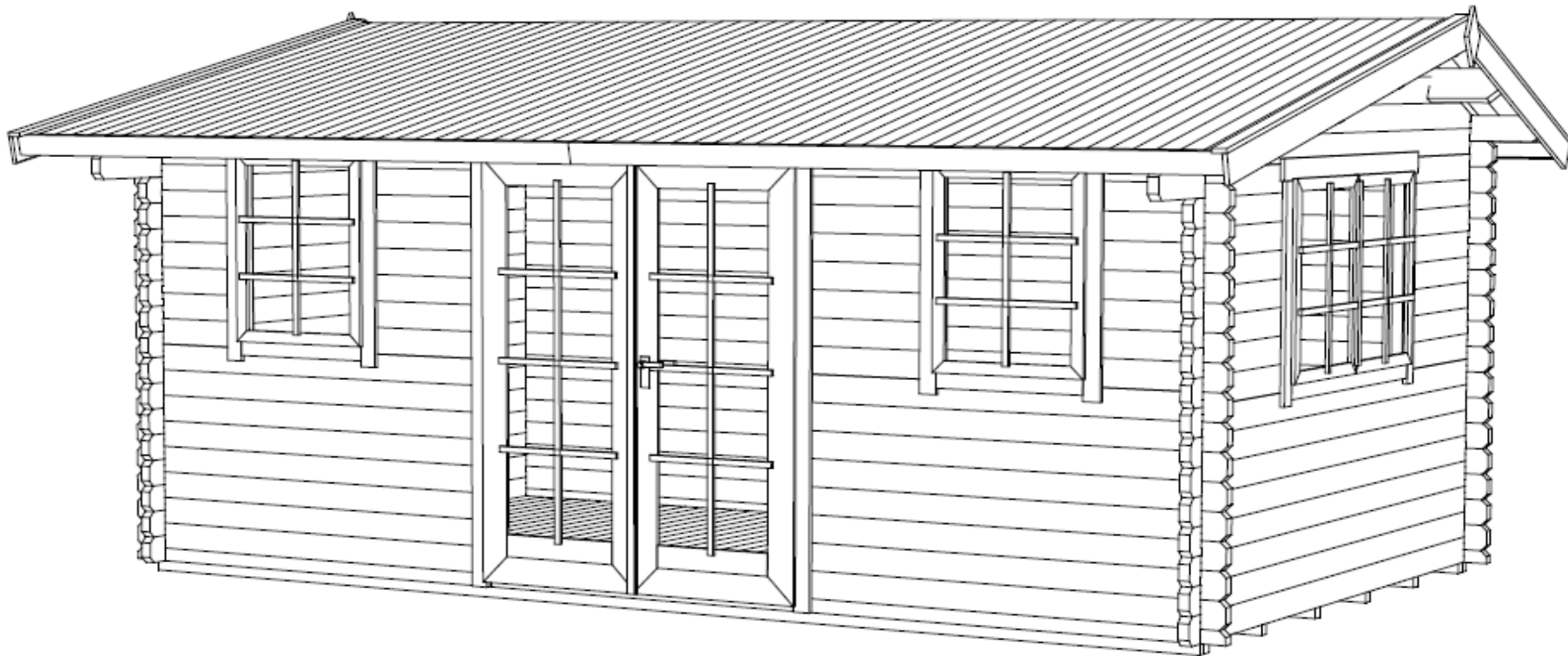

10.05.2013

Art.Nr. 4413040

GROUNDPLAN - GRUNDPLAN - PLAN DE MASSE

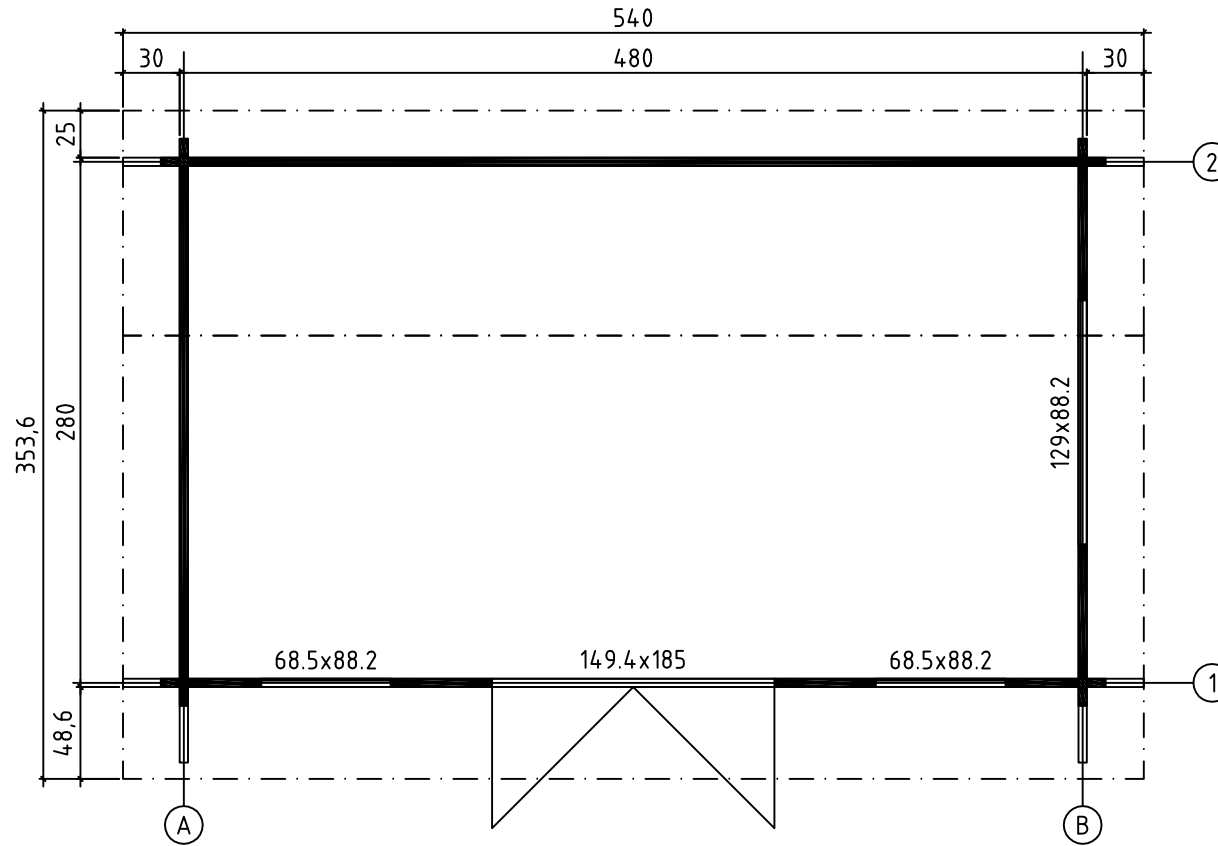

FOUNDATION - FUNDAMENT - FONDATION

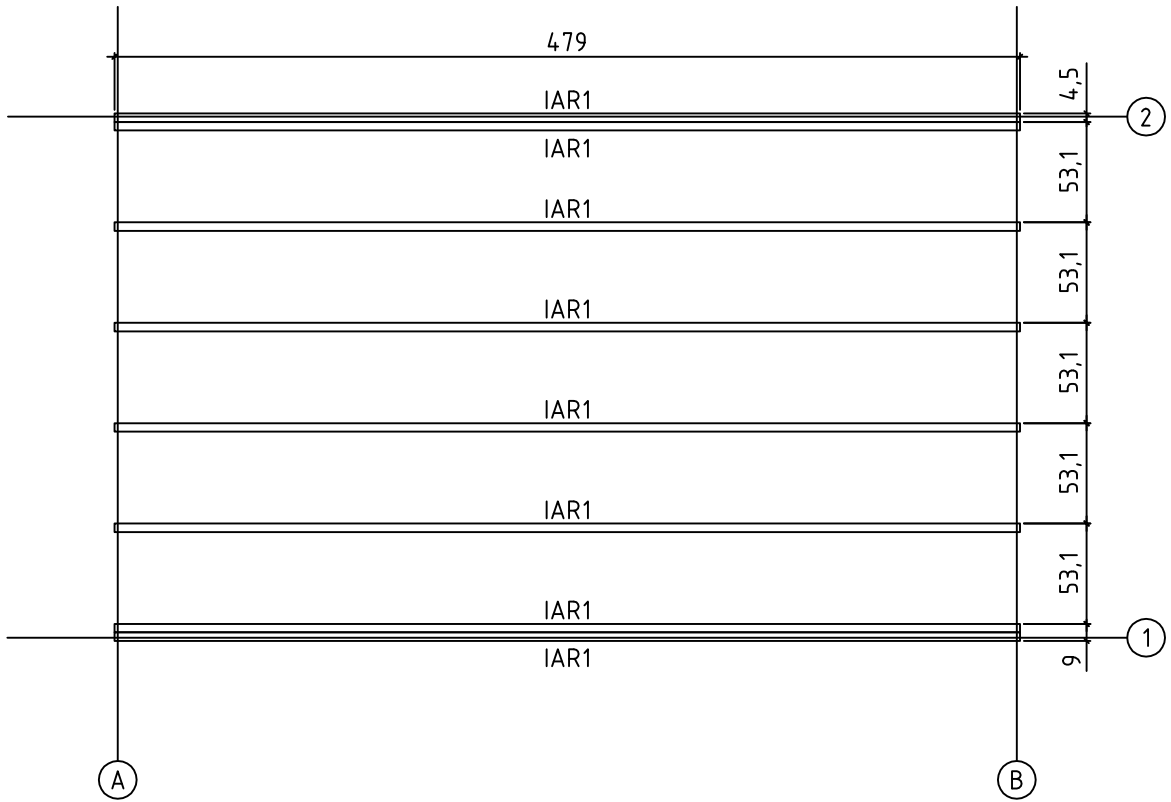



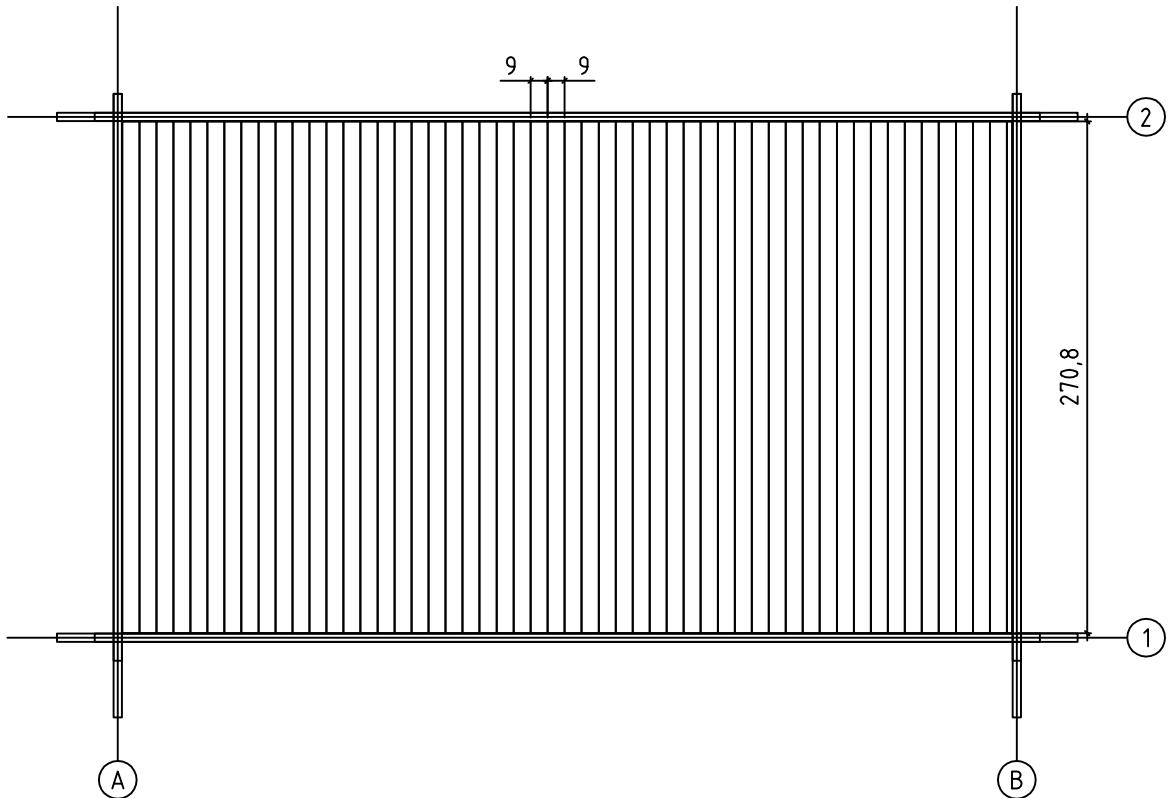

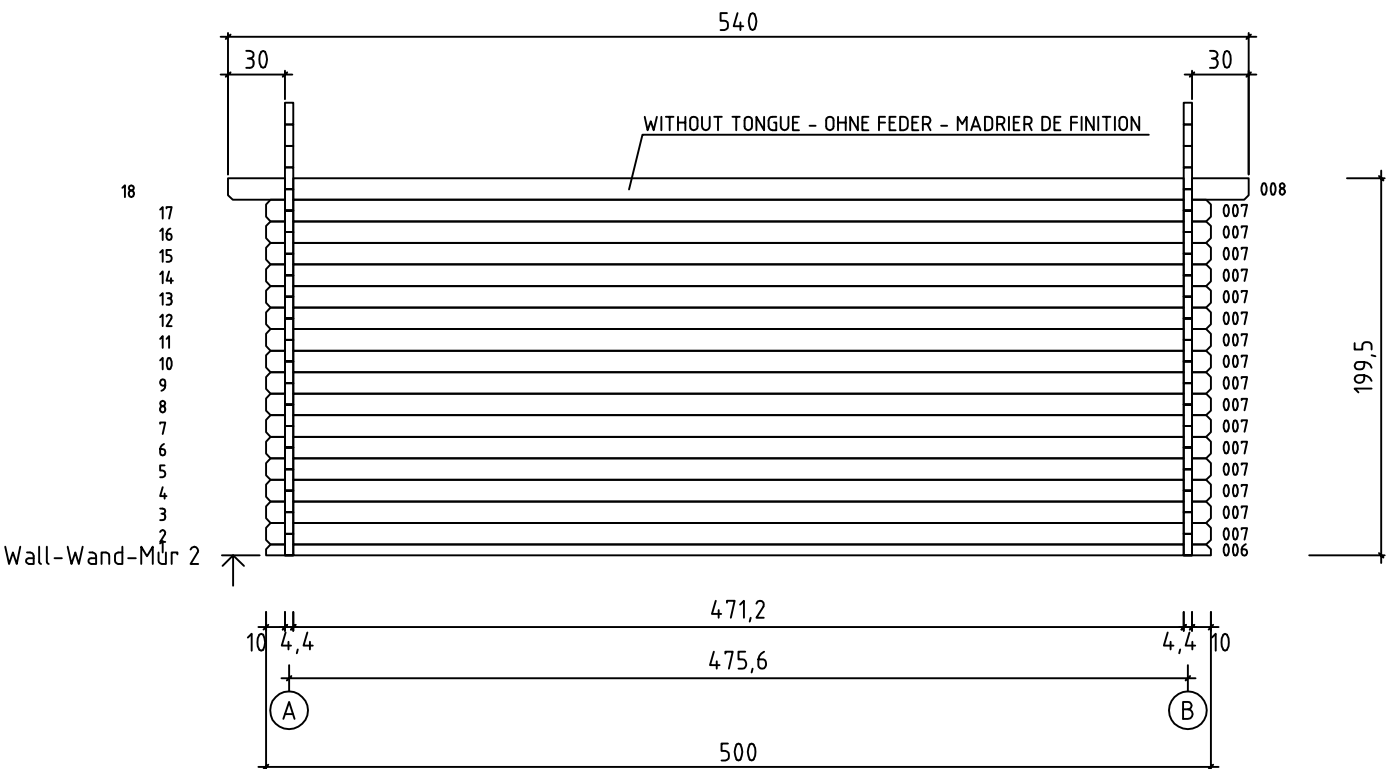
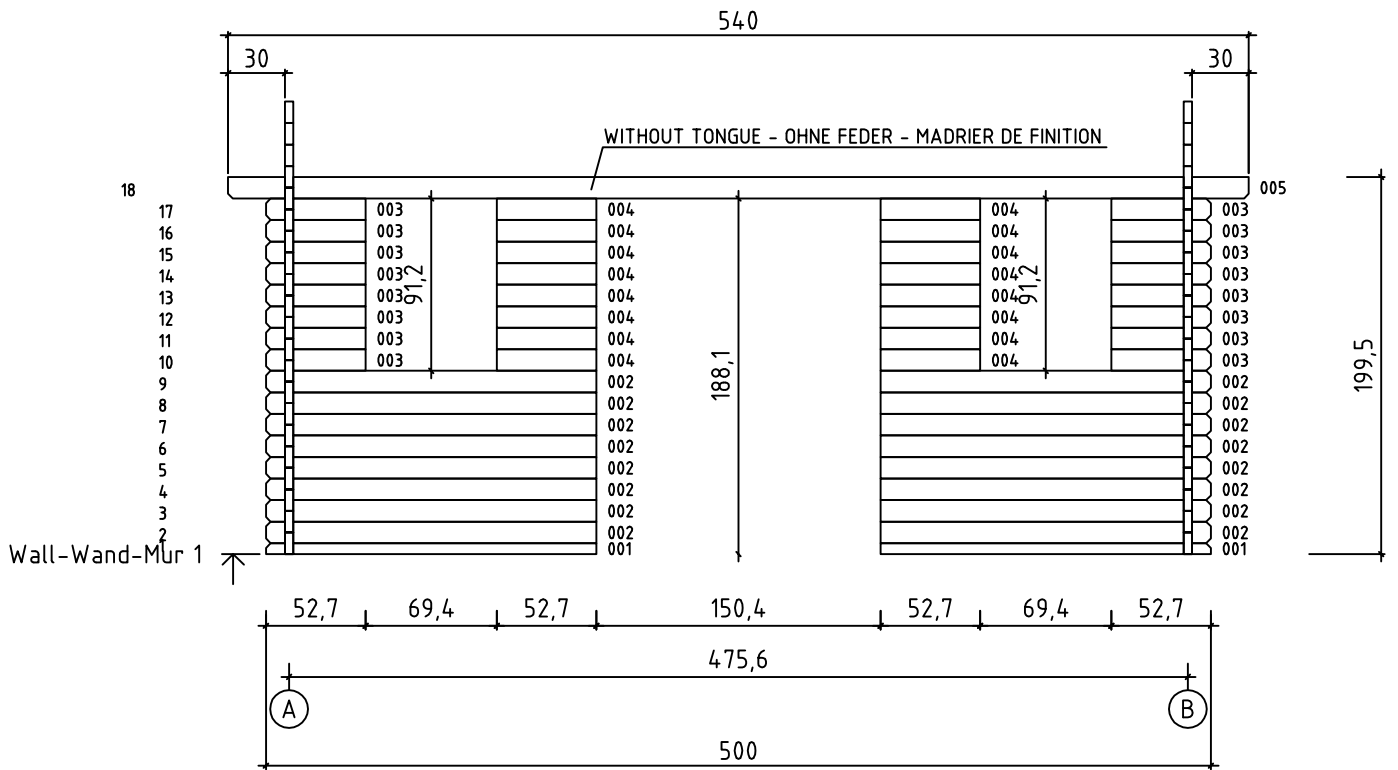

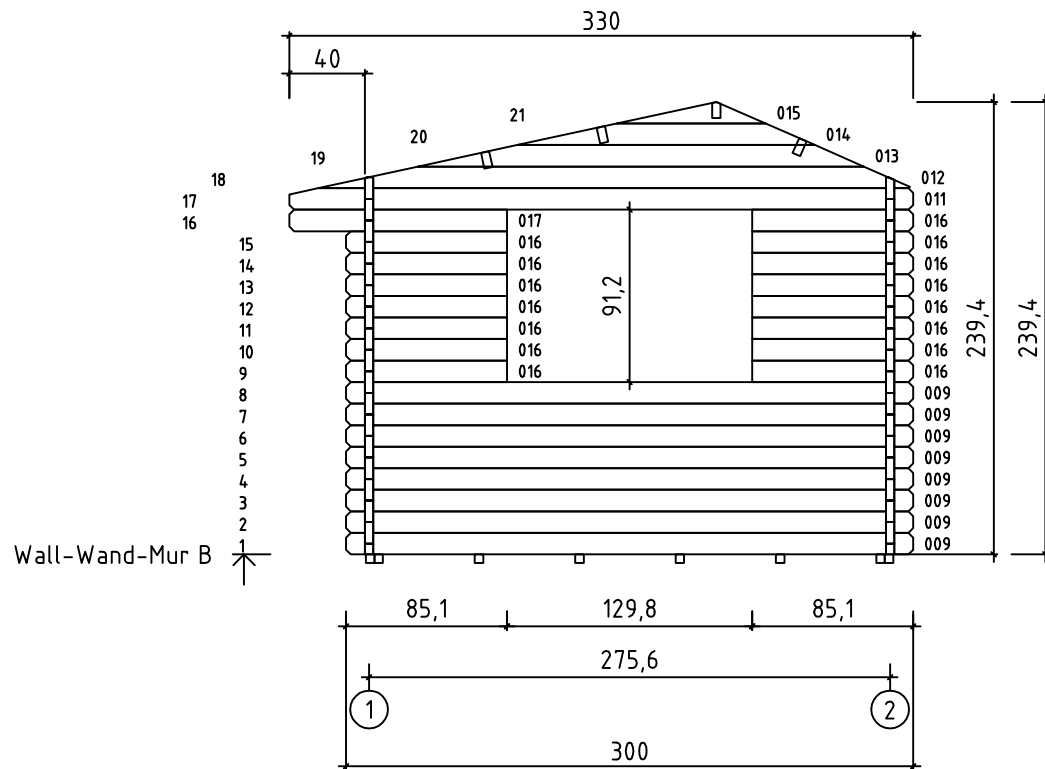
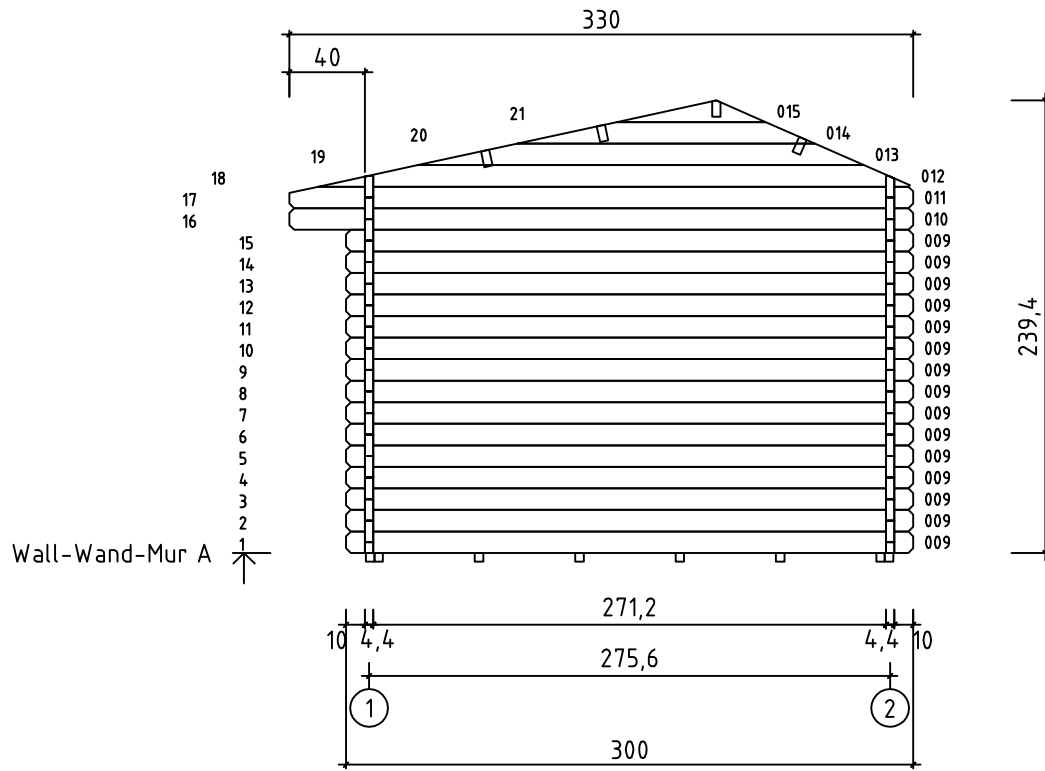

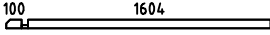
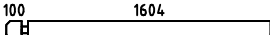

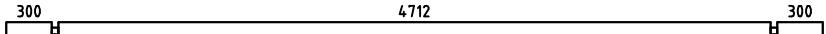
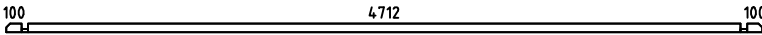
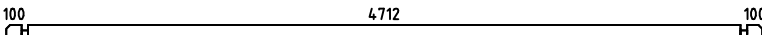
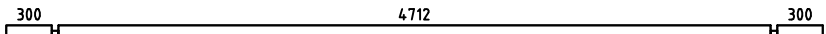
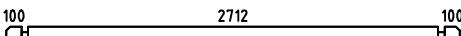
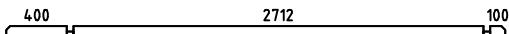
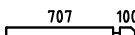

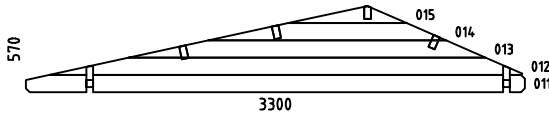
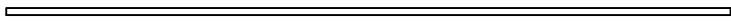
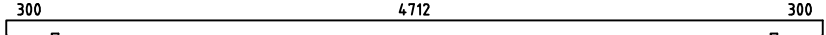
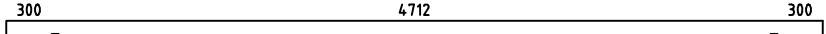





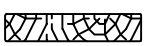



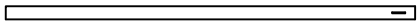
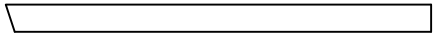
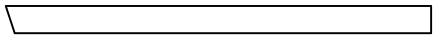
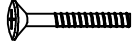
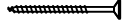

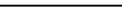
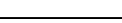

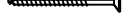
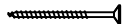

FLOOR BOARDS - FUSSBODENBRETTER - PLAN POSE PLANCHER







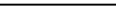
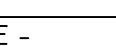
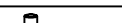

Pos	10.05.2013	Piecelist - Stücklist - Liste des composants Art.Nr. 4413040	6/8	Q.	P. (mm)	L. (mm)
001				2	44x57	1748
002				16	44x114	1748
003				16	44x114	527
004				16	44x114	527
005				1	44x120	5400
006				1	44x57	5000
007				16	44x114	5000
008				1	44x120	5400
009				23	44x114	3000
010				1	44x114	3300
016				15	44x114	851
017				1	44x114	1151
WA-1				1		
WB-1				1		
IAR1		FOUNDATION - FUNDAMENT - FONDATION 		8	45x45	4790
PR1		ROOF BEAM - DACHBALKEN - PANNE DE TOIT 4712 		1	44x140	5400
A-PR1		ROOF BEAM - DACHBALKEN - PANNE DE TOIT 4712 		3	44x140	5400
		FLOOR BOARDS - FUSSBODENBRETTEN - LAME DE PLANCHER 		53	90x18	2708
		ROOF BOARDS - DACHBRETTEN - VOLIGES 		60	90x18	2400
		ROOF BOARDS - DACHBRETTEN - VOLIGES 		60	90x18	1300
		FLOOR FILLET-FUSSBODENLEISTE - CORNIERE DE FINITION DU PLANCHER 			18x18	14.83
		ROOFING FELT FILLET - DACHPAPPENLEISTE - BAGUETTE DE FIXATION DU FEUTRE BITUMEUX 		2	18x58	1350
		ROOFING FELT FILLET - DACHPAPPENLEISTE - BAGUETTE DE FIXATION DU FEUTRE BITUMEUX 		2	18x58	2450
		EAVES BOARD - TRAUFBRETT - BANDEAU DE TOIT 		4	18x90	2700
		ROOF EDGE REINFORCEMENT - DACHRANDVERSTÄRKUNG - CORNIERE DE RENFORT DE BORD DE TOIT 		4	28x34	2700

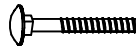
Pos	10.05.2013	Piecelist - Stücklist - Liste des composants Art.Nr. 4413040	7/8	Q.	P. (mm)	L. (mm)
		STORM PROTECTION - STURMLEISTE - - LATTE ANTI-TEMPETE 		4	22x45	1900
		GABLE MOULDING - GIEBELLEISTE - - PLANCHE DE RIVE 		2	18x120	1350
		GABLE MOULDING - GIEBELLEISTE - - PLANCHE DE RIVE 		2	18x120	2450
		BOLT FOR WINDOW HANDLE FITTINGS - BOLZEN FÜR FENSTERGRIFF BESCHLAG - BOULON POUR POIGNÉE D'OUVERTURE DE FENETRE 		6		
		SCREW FOR ROOF BEAMS - SCHRAUBEN FÜR DACHBALKEN - - VIS POUR PANNE DE TOIT 		12	5x120	
		SCREW FOR 1. WALL BEAM - SCHRAUBE FÜR 1. BOHLENREIHE - - VIS DE FIXATION DES FONDATIONS 		8	5x90	
		SCREW FOR DOOR JAMB - SCHRAUBE FÜR TÜRRAHMEN - - VIS DE FIXATION POUR MONTANT DE PORTE 		4	5x90	
		SCREW FOR GEORGIAN BARS - SCHRAUBE FÜR SPROSSEN - - VIS DE BARRES GEORGIENNE 		40	2.5x20	
		SCREW FOR GABLE SEGMENT - SCHRAUBEN FÜR DECKBLATT - VIS POUR FIXATION LOSANGE DE FINITION 		4	3.5x35	
		SCREW FOR GABLE MOULDING - SCHRAUBEN FÜR GIEBELLEISTE - VIS DE FIXATION POUR PLANCHE DE RIVE 		28	3.5x50	
		SCREW FOR DOOR FILLET - SCHRAUBE ZUR BEFESTIGUNG TÜRLEISTE - VIS D'ASSEMBLAGE DU CADRE DE PORTE 		5	3x30	
		SCREW FOR EAVES BOARDS - SCHRAUBEN FÜR TRAUFBRETTER - VIS DE FIXATION POUR BANDEAU DE TOIT 		24	4x40	
		SCREW FOR FUNDAMENT - SCHRAUBEN ZUR BEFISTIGUNG FUNDAMENT - VIS POUR FONDATION 		8	5x90	
		WINDOW HANDLE FITTINGS - FENSTERGRIFF - - POIGNÉE D'OUVERTURE DE FENETRE 		2		
		WINDOW HANDLE FITTINGS - FENSTERGRIFF - - POIGNÉE D'OUVERTURE DE FENETRE 		1		
		ZN NAIL FOR FLOOR FILLET - ZN NÄGEL FÜR FUSSBODENLEISTE - POINTE POUR CORNIERE DE FINITION DU PLANCHER 		30	1.4x40	
		SET OF DOOR LOCK COVERS - SCHLOSSBLENDEN - - SET DE GARNITURES DE SERRURE DE PORTE 		1		
		HAMMER BLOCK - SCHLAGHOLZ - CALLE DE FRAPPE 		1		
		SCREW FOR DOORSTEP - SCHRAUBEN FÜR SWELLE - - VIS DE FIXATION DU SEUIL DE PORTE 		3	4.5x65	
		ZN NAIL FOR ROOF - ZN NÄGEL FÜR DACHBRETTER - POINTE POUR TOIT 		377	2x50	
		ZN NAIL FOR FLOOR - ZN NÄGEL FÜR FUSSBODENBRETTER - - CLOUS POUR PLANCHER 		324	2x50	
		ZN NAIL FOR ROOFING FELT FILLET - ZN NÄGEL FÜR DACHPAPPENLEISTE - - POINTE POUR BAGUETTE FIXATION FEUTRE BITUMEUX 		20	2x40	
		MALE BOLT HINGE FOR DOOR - TÜRRIEGEL - - PARTIE MALE DE CHARNIERE DE PORTE 		6		
		SCREW FOR ROOF EDGE REINFORCEMENT - SCHRAUBEN FÜR DACHRANDVERSTÄRKUNG - VIS POUR RENFORT DE BORD DE TOIT 		24	4x40	
		GABLE SEGMENT-DECKBLATT - LOSANGE DE FINITION 		2		

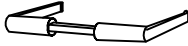
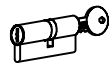
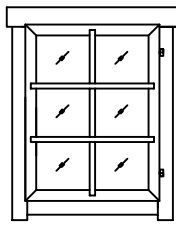
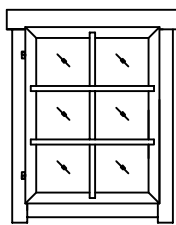
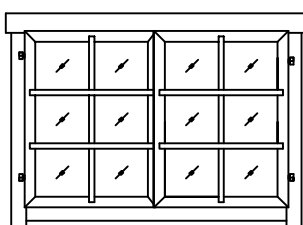
Pos	10.05.2013	Piecelist - Stücklist - Liste des composants Art.Nr. 4413040	8/8	Q.	P. (mm)	L. (mm)
		NUT FOR STORM PROTECTION - SCHRAUBENMUTTER FÜR STURMLEISTE - - ÉCROU POUR LAME ANTI-TEMPETE		8		
		BOLT FOR STORM PROTECTION - BOLZEN FÜR STURMLEISTE - - VIS POUR LAME ANTI-TEMPETE		8		
		WASHER FOR STORM PROTECTION - DICHTSCHEIBE FÜR STURMLEISTE - - RONDELLE POUR LAME ANTI-TEMPETE		8		
		DOOR HANDLE FITTINGS - TÜRGRIF - SET DE GARNITURES DE SERRURE DE PORTE		1		
		CYLINDER LOCK - ZYLINDERSCHLOSS - CYLINDRE DE SERRURE		1		
		WINDOW - FENSTER - FENETRE 685x882	AK.1.106.PVP.d	1		
						
		WINDOW - FENSTER - FENETRE 685x882	AK.1.106.PVV.d	1		
						
		WINDOW - FENSTER - FENETRE 1290x882	TAK.1.106.PVP.a	1		
						
		DOOR - TÜR - PORTE 1494x1850	TUK.1.108.PVP.MMc	1		
		