

Aruba 1 - Art.Nr. 441900

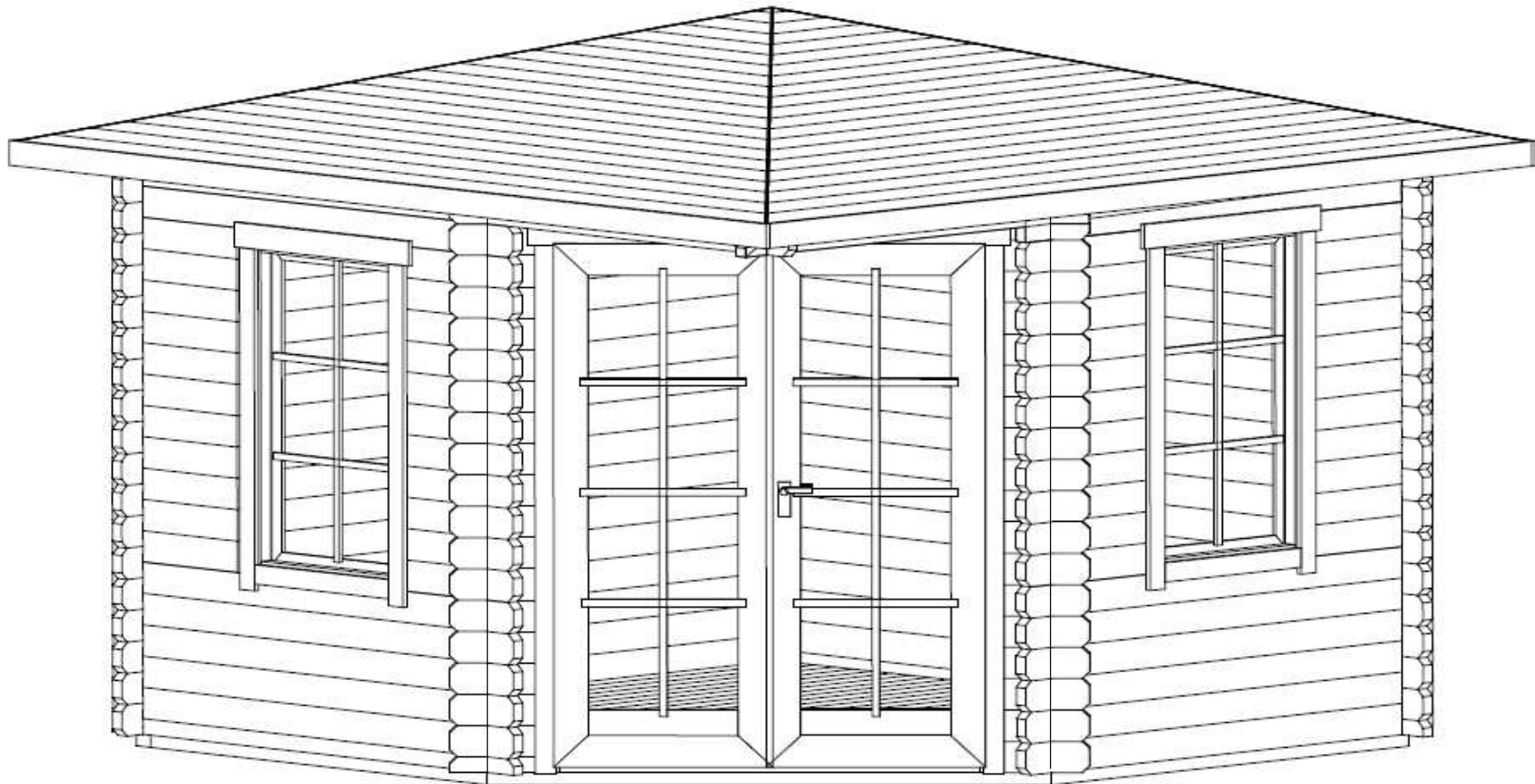

GROUNDPLAN - GRUNDPLAN - PLAN DE MASSE

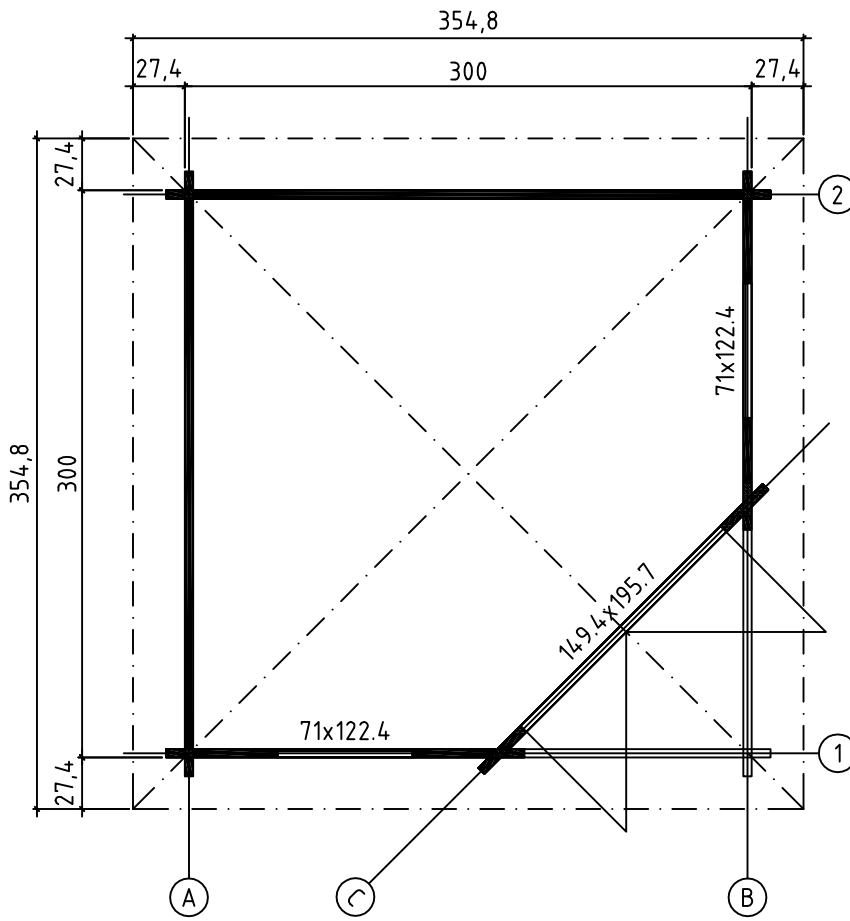

FOUNDATION - FUNDAMENT - FONDATION

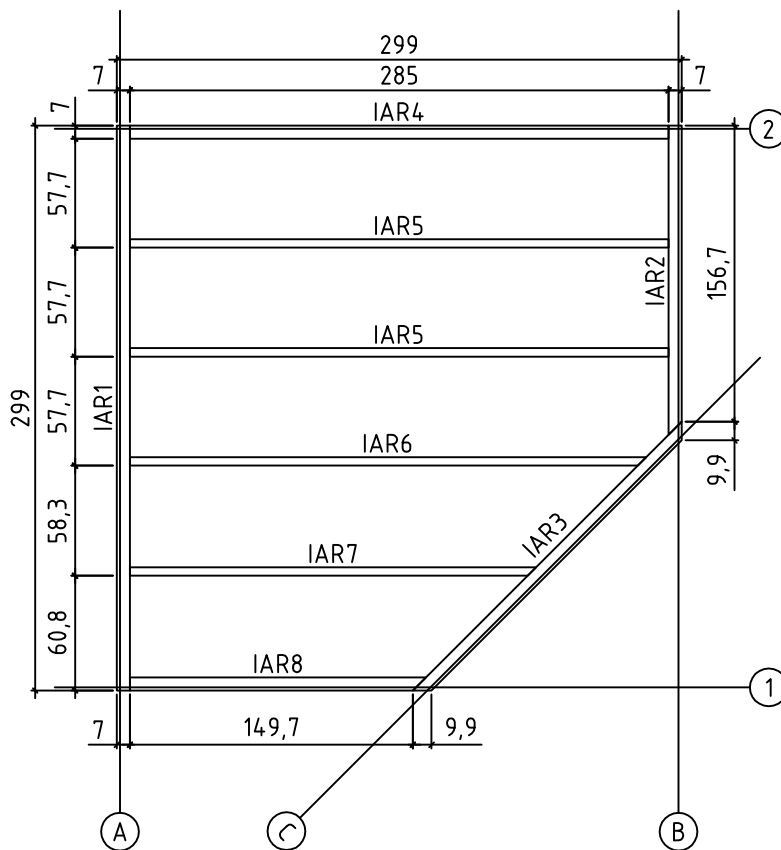

FLOOR BOARDS - FUSSBODENBRETTER - LAME DE PLANCHER

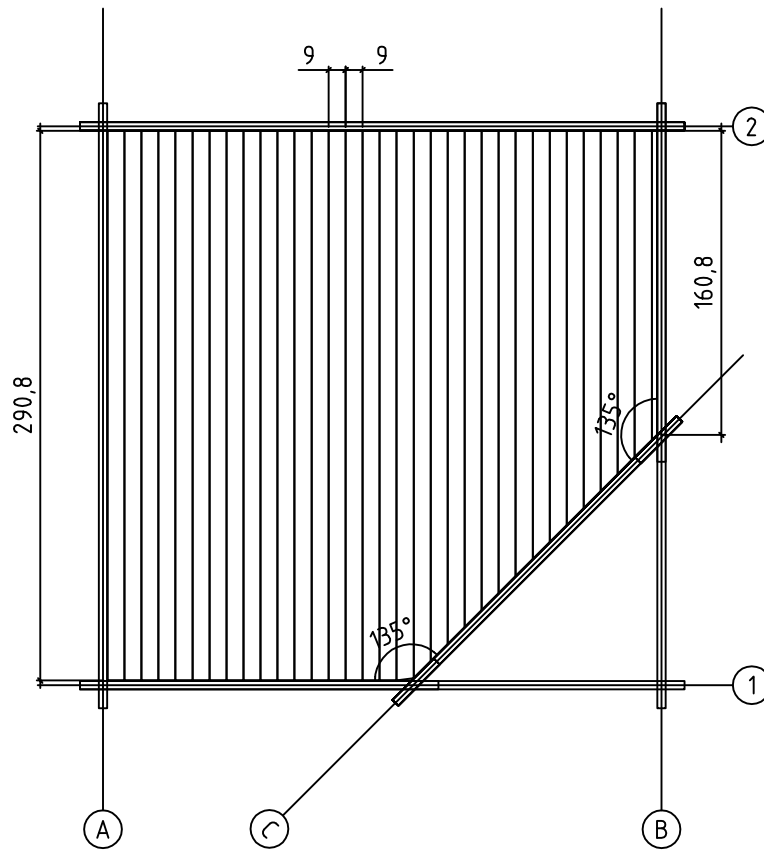

OVERHEAD BEAMS - DECKENBALKEN - SOLIVES

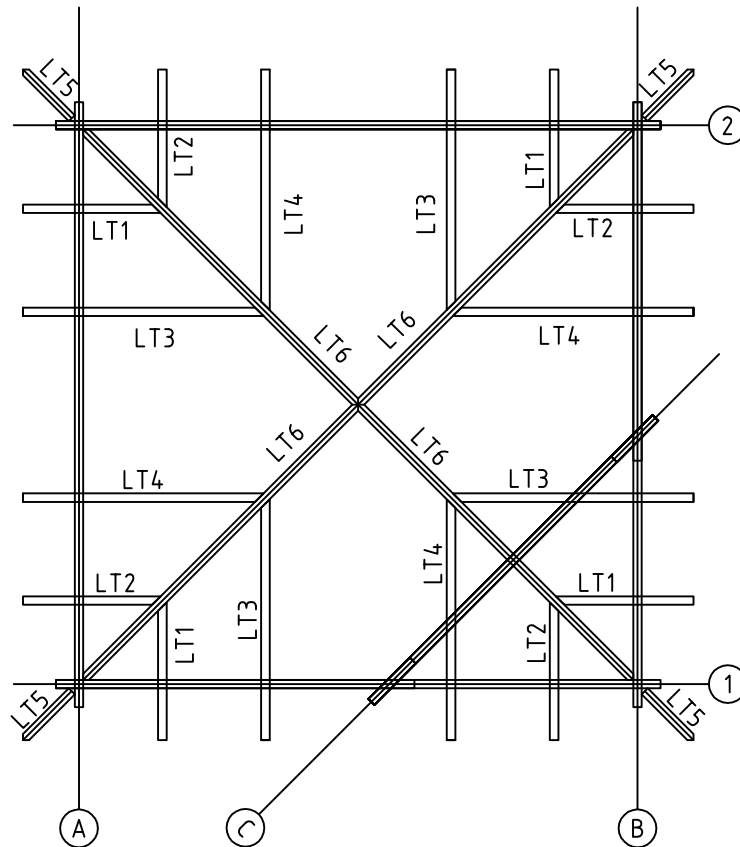

Art.Nr. 441900

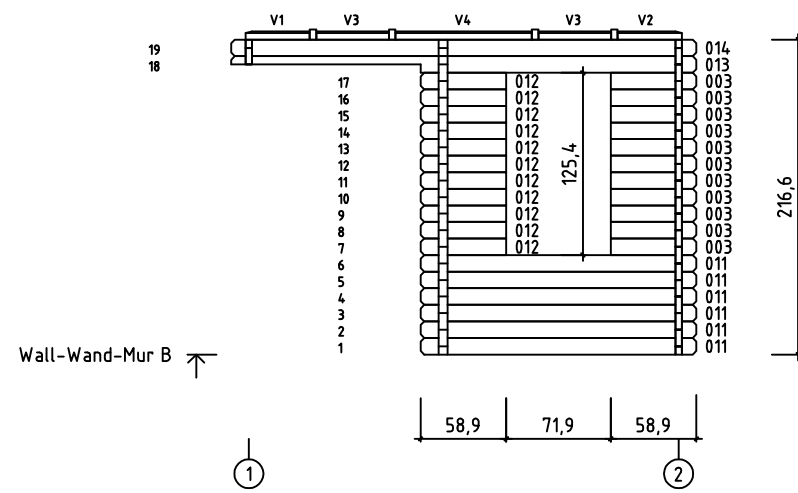
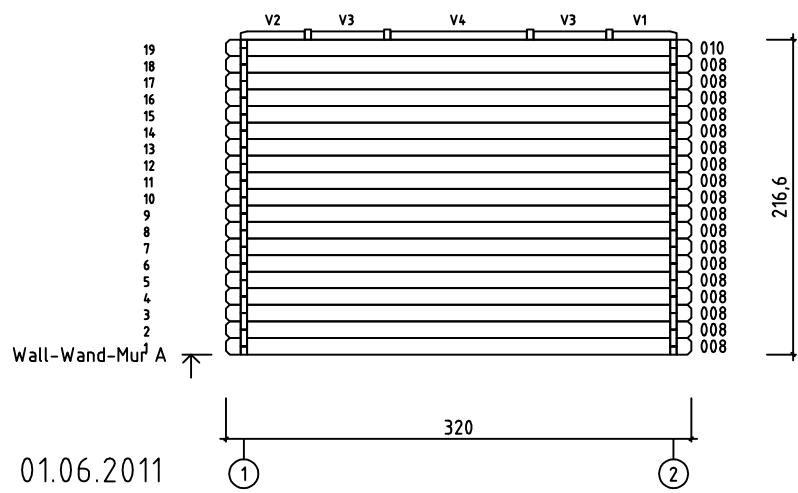
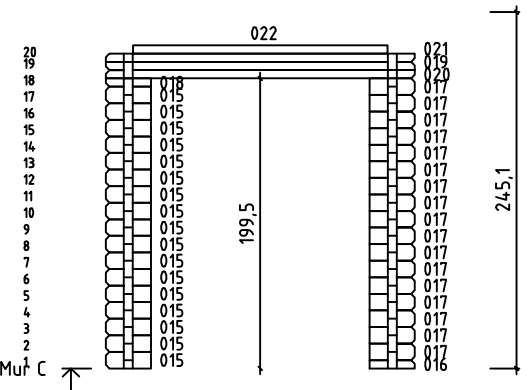
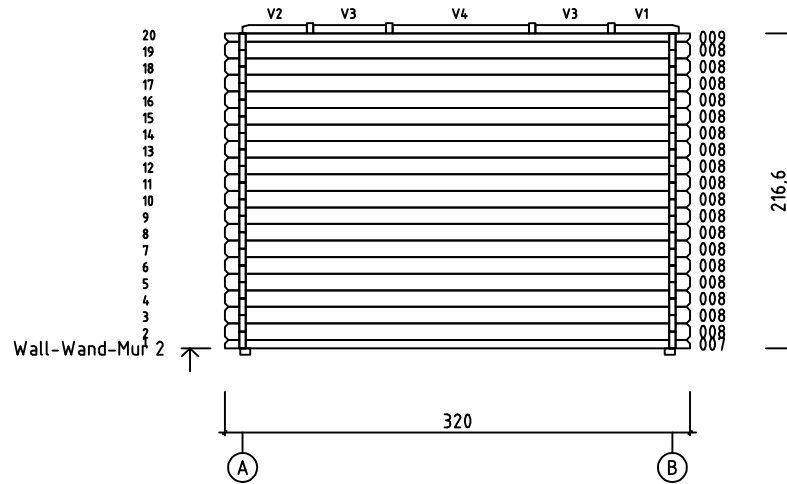
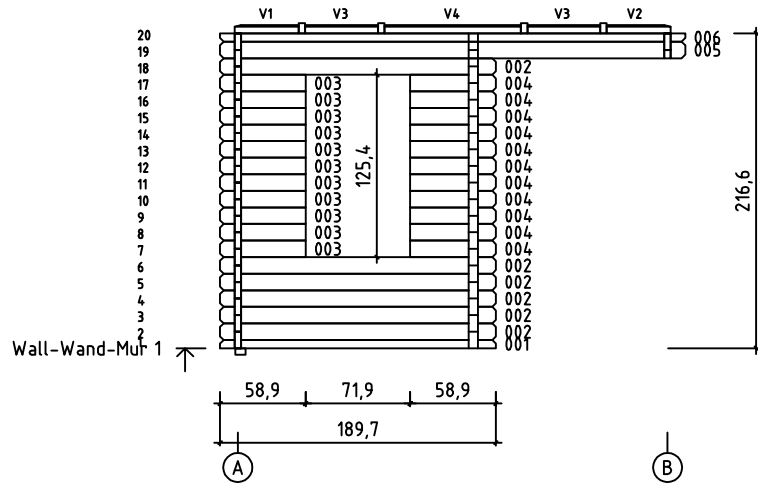

01.06.2011

TRIANGULAR'S FILLET - LEISTE FÜR DREIECKIGE - LITEAU - 28x34

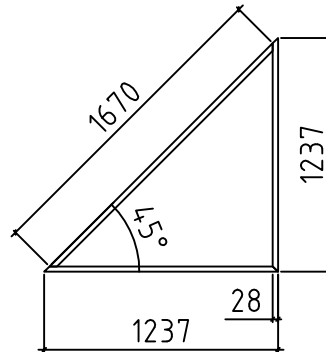

A = 1237 mm

2 St.

B = 1670 mm





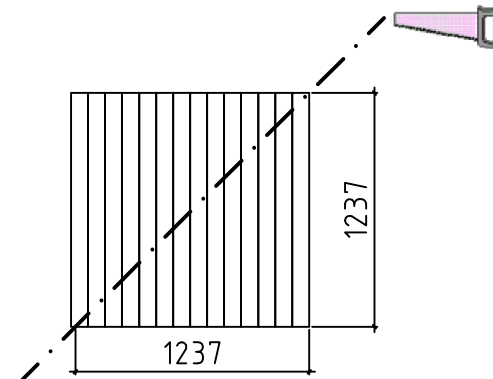
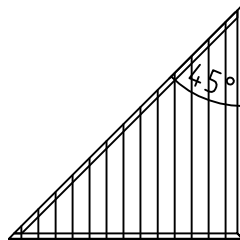

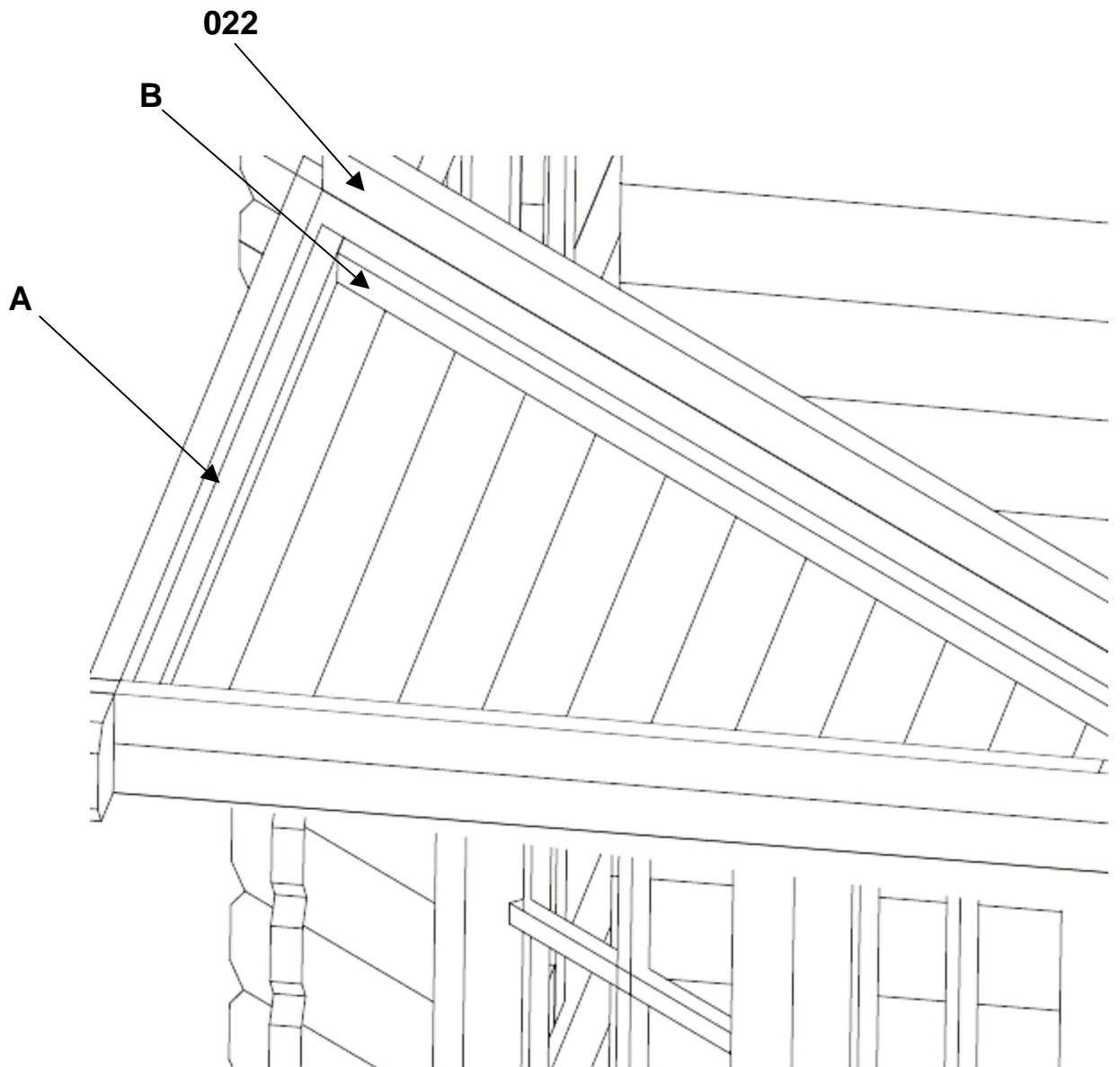



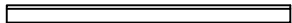
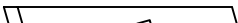
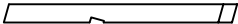
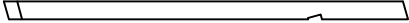
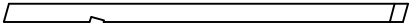
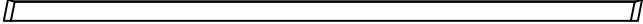

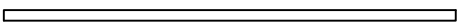
1 St.

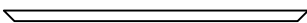



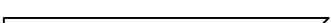
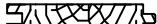

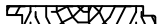
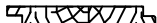
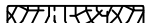
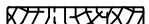

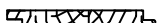
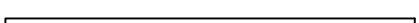

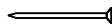
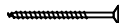
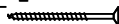
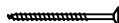
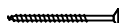

TRIANGULAR'S BOARDS -DACHBRETTER FÜR DREIECKIGE - PLANCHES - 18x90



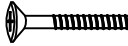
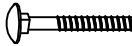
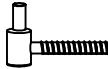
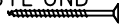
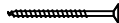
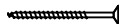

Pos	01.06.2011	Piecelist - Stücklist - Liste des composants Art.Nr. 441900	7/10	Q.	P. (mm)	L. (mm)
001				1	44x57	1897
002				6	44x114	1897
003				22	44x114	589
004				11	44x114	589
005				1	44x114	3200
006				1	44x57	3200
007				1	44x57	3200
008				36	44x114	3200
009				1	44x57	3200
010				1	44x114	3200
011				6	44x114	1897
012				11	44x114	589
013				1	44x114	3200
014				1	44x114	3200
015				17	44x114	310
016				1	44x57	310
017				17	44x114	310
018				1	44x57	310
019				1	44x57	2125
020				1	44x57	2125
021				1	44x57	2125
022				1	44x57	1752
V1	WALL BELT - WAND BELT - CEINTURE DE MUR			4	44x57	441
V2	WALL BELT - WAND BELT - CEINTURE DE MUR			4	44x57	441
V3	WALL BELT - WAND BELT - CEINTURE DE MUR			8	44x57	500

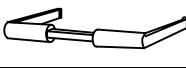
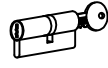
Pos	01.06.2011	Piecelist - Stücklist - Liste des composants Art.Nr. 441900	8/10	Q.	P. (mm)	L. (mm)
V4		WALL BELT - WAND BELT - CEINTURE DE MUR 		4	44x57	938
LT1		OVERHEAD BEAMS - DECKENBALKEN - ARBALÉTRIER 		4	45x60	771
LT2		OVERHEAD BEAMS - DECKENBALKEN - ARBALÉTRIER 		4	45x60	771
LT3		OVERHEAD BEAMS - DECKENBALKEN - ARBALÉTRIER 		4	45x60	1336
LT4		OVERHEAD BEAMS - DECKENBALKEN - ARBALÉTRIER 		4	45x60	1336
LT6		OVERHEAD BEAMS - DECKENBALKEN - CHEVRON D'ARÉTLER 		4	45x70	2111
LT5		OVERHEAD BEAMS - DECKENBALKEN - CHEVRON D'ARÉTLER 		4	45x70	401
IAR1		FOUNDATION - FUNDAMENT - FONDATION 		1	70x45	2990
IAR4		FOUNDATION - FUNDAMENT - FONDATION 		1	70x45	2850
IAR3		FOUNDATION - FUNDAMENT - FONDATION 		1	70x45	2013
IAR2		FOUNDATION - FUNDAMENT - FONDATION 		1	70x45	1637
IAR8		FOUNDATION - FUNDAMENT - FONDATION 		1	70x45	1567
IAR5		FOUNDATION - FUNDAMENT - FONDATION 		2	45x45	2850
IAR6		FOUNDATION - FUNDAMENT - FONDATION 		1	45x45	2732
IAR7		FOUNDATION - FUNDAMENT - FONDATION 		1	45x45	2150
		FLOOR BOARDS - FUSSBODENBRETTER - LAME DE PLANCHER 		33	90x18	2908
		FLOOR FILLET-FUSSBODENLEISTE - CORNIERE DE FINITION DU PLANCHER 			18x18	10.87
		ROOF BOARDS - DACHBRETTER - VOLIGE 		42	90x18	3626
		ADDITIONAL ROOF BOARDS - ZUSATZDACHBRETTER - LA LATTE SUPPLÉMENTAIRE AU VOLIGES DU TOIT 		2	90x18	3722
		EAVES BOARD - TRAUFBRETT - BANDEAU DE TOIT 		2	18x90	3548
		EAVES BOARD - TRAUFBRETT - BANDEAU DE TOIT 		2	18x90	3584
A		TRIANGULAR'S FILLET - LEISTE FÜR DREIECKIGE - - LITEAU 		2	28x34	1237
B		TRIANGULAR'S FILLET - LEISTE FÜR DREIECKIGE - - LITEAU 		1	28x34	1670
		TRIANGULAR'S BOARDS -DACHBRETTER FÜR DREIECKIGE- - PLANCHES 		14	90x18	1237
		STORM PROTECTION - STURMLEISTE - - LATTE ANTI-TEMPETE 		5	22x45	2100

Pos	01.06.2011	Piecelist - Stücklist - Liste des composants Art.Nr. 441900	9/10	Q.	P. (mm)	L. (mm)
		HAMMER BLOCK - SCHLAGHOLZ - CALLE DE FRAPPE 44mm		1		300
		WINDOW HANDLE FITTINGS-FENSTERGRIFF - POIGNÉE D'OUVERTURE DE FENETRE		4		
		ZN NAIL FOR FLOOR FILLET - ZN NÄGEL FÜR FUSSBODENLEISTE - - POINTE POUR CORNIERE DE FINITION DU PLANCHER		22	1.4x40	
		SCREW FOR FILLET - SCHRAUBE ZUR BEFESTIGUNG TÜRLEISTE - - VIS D'ASSEMBLAGE DU CADRE DE PORTE		5	3x30	
		SCREW FOR TRIANGULAR FIXING - MONTAGENSCHRAUBE FÜR DREIECKIGE - - VIS D'ASSEMBLAGE POUR TRIANGLE		10	4x60	
		SCREW FOR 1. WALL BEAM - SCHRAUBE FÜR 1. BOHLENREIHE - - VIS DE FIXATION DES FONDATIONS		6	5x90	
		SCREW FOR DOOR JAMB - SCHRAUBE FÜR TÜRRAHMEN - - VIS DE FIXATION POUR MONTANT DE PORTE		4	5x90	
		SCREW FOR OVERHEAD BEAMS - SCHRAUBEN FÜR DECKENBALKEN - - VIS DE FIXATION POUR ARBALÉTRIER (LT1-LT4)		32	6x80	
		DOOR HANDLE FITTINGS-TÜRGRIFF - SET DE GARNITURES DE SERRURE DE PORTE		1		
		SCREW FOR DOORSTEP - SCHRAUBEN FÜR SWELLE - VIS DE FIXATION DU SEUIL DE PORTE		3	4.5x65	
		NUT FOR STORM PROTECTION - SCHRAUBENMUTTER FÜR STURMLEISTE - - ÉCROU POUR LAME ANTI-TEMPETE		10		
		BOLT FOR WINDOW HANDLE FITTINGS - BOLZEN FÜR FENSTERGRIFF BESCHLAG - BOULON POUR POIGNÉE D'OUVERTURE DE FENETRE		8		
		BOLT FOR STORM PROTECTION - BOLZEN FÜR STURMLEISTE - - VIS POUR LAME ANTI-TEMPETE		10		
		MALE BOLT HINGE FOR DOOR - TÜRRIEGEL - PARTIE MALE DE CHARNIERE DE PORTE		6		
		SCREW FOR TRIANGULAR FILLET AND BOARDS - SCHRAUBEN FÜR LEISTE UND BRETTER - VIS DE FIXATION LITEAU ET PLANCHES		30	4x40	
		SCREW FOR EAVES BOARDS - SCHRAUBEN FÜR TRAUFBRETTER - - VIS DE FIXATION POUR BANDEAU DE TOIT		40	4x40	
		SCREW FOR FUNDAMENT - SCHRAUBEN ZUR BEFESTIGUNG FUNDAMENT - - VIS POUR FONDATION		13	5x120	
		WASHER FOR STORM PROTECTION - DICHTSCHEIBE FÜR STURMLEISTE - - RONDELLE POUR LAME ANTI-TEMPETE		10		
		ZN NAIL FOR ROOF - ZN NÄGEL FÜR DACHBRETTER - POINTE POUR TOIT		340	2x50	
		ZN NAIL FOR FLOOR - ZN NÄGEL FÜR FUSSBODENBRETTER - - CLOUS POUR PLANCHER		190	2x50	
		DOOR HANDLE FITTINGS-TÜRGRIFF - GARNITURE DE POIGNÉE DE PORTE		1		
		CYLINDER - ZYLINDERSCHLOSS - CYLINDRE DE SERRURE		1		
		SCREW FOR LT5 AND LT6 - SCHRAUBEN FÜR LT5 UND LT6 - - VIS DE FIXATION POUR CHEVRON D'ARÉTLER (LT5-LT6)		12	5x120	
		SCREW FOR WALL BELT - SCHRAUBEN FÜR WAND BELT - - VIS POUR CEINTURE DE MUR		43	5x90	

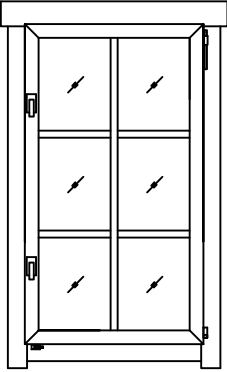
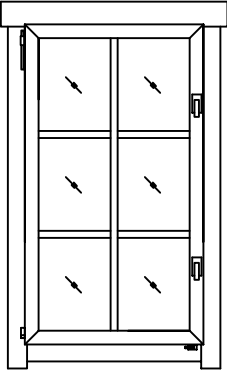
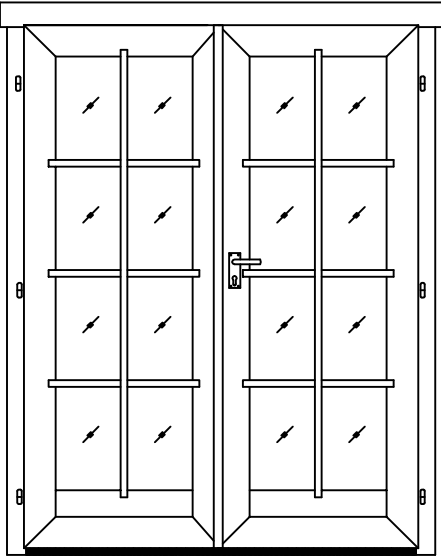
Pos	01.06.2011 Piecelist - Stücklist - Liste des composants Art.Nr. 441900	10/10	Q.	P. (mm)	L. (mm)
	WINDOW - FENSTER - FENETRE 710x1224 	AK.1.106.SSP	1		
	WINDOW - FENSTER - FENETRE 710x1224 	AK.1.106.SSV	1		
	DOOR - TÜR - PORTE 1494x1957 	TUK.1.108.SVP.MMb	1		